

# TOYOTA A40 SERIES RWD

# ISUZU, VOLVO, MITSUBISHI



Transmission  
A40D



Transmission  
A42D, A43D,  
AW70, AW71



Transmission  
A43DE,  
A46DE



Transmission  
A42DL, A43DL,  
A44DL, A45DL,  
A45DF

See End Of This Section For  
Additional Illustrations &  
Identification Information

TOYOTA — REAR WHEEL DRIVE	MITSUBISHI — REAR WHEEL DRIVE
<b>A40, A41, A43</b> - 3 Spd.	<b>A44D, RAM 50, AW372</b> - 4 Spd.,
<b>A40D, A42D, A43D, A44D</b> - 4 Spd. Overdrive	<b>AW3072L, A44DL</b> - 2WD 87-Up
<b>A42DL, A43DE, A43DL</b> - 4 Spd. Overdrive - L/U (DE w/Electronic Controls)	<b>A44D</b> - Raider, Montero - 4WD 83-84
<b>A44DL</b> - Van - 4 Spd. Overdrive - L/U 83-Up	<b>KM148</b> - 4WD - Van 87-Up
<b>A45DF (4WD), A45DL (2WD)</b> - Van 87-Up	
<b>A46DE</b> - Previa Van 91-Up	
	<b>GEO/SUZUKI</b>
	<b>A44DE</b> - Tracker, Sidekick, X-90 92-Up
	<b>CHRYSLER</b>
	<b>A44D</b> - D50 Pickup, Raider 87-89
	<b>MAZDA</b>
	<b>A44DE</b> - Miata 98-99
	<b>KIA</b>
	<b>A44DE (03-72LE)</b> - Sportage 97-98
<b>VOLVO — REAR WHEEL DRIVE</b>	
<b>AW55</b> (Japan Built), <b>BW55</b> (England Built) - 3 Spd.	
<b>AW70, AW71</b> - 4 Spd. Overdrive	
<b>AW70L, AW72L</b> - 4 Spd. Overdrive w/Lock Up	
<b>ISUZU — REAR WHEEL DRIVE</b>	
<b>A40</b> - 3 Spd., I-Mark, Pickup 81-Up	
<b>A42D, A43D</b> - 4 Spd. Overdrive, Impulse 83-87	
<b>A44DL</b> - Impulse - Pickups, Amigo 85-Up	

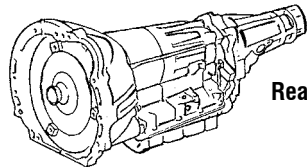

Rear Wheel Drive

### IMPORTANT NOTE

Due to the variety of kits available to service Toyota A40 series, and the mid-producton changes, it is imperative that proper identification is made. Please read **ALL** footnotes, prior to ordering, to avoid error.

ILL.	DESCRIPTION	QTY.	YEAR	PART NO.	REFERENCE NO.
<b>MASTER OVERHAUL KITS (WITH STEELS)</b>					
006E	A40, A41, A43 .....	1	73-Up	57006AF	K4600
006E	A40D, A42D, A43D, A44D .....	1	76-Up	57006CCF	K4600D
006E	A42DE, A42DL, A43DE, A43DL, A44DE, A44DL, A45DL .....	1	8/81-Up	57006HCF	K4600F/G
006E	A46DE, A46DF .....	1	90-95	57006PF	K4600H
006E	AW55 .....	1	73-Up	57006AF	K4600
006E	AW70, AW71, AW72 (Non Lock-up) (Volvo - Add 29074) .....	1	76-Up	57006CCF	K4600D
006E	AW70L, AW71L, AW72L (Lock-up) .....	1	8/81-Up	57006HCF	K4600F
006E	BW55 (Volvo) .....	1	74-81	57006YF	K4600A
<b>LESS STEEL KITS</b>					
004E	A40, A41, A43 .....	1	73-Up	57004AF	K4600-LS
004E	A40D, A42D, A43D, A44D .....	1	76-Up	57004CCF	K4600D-LS
004E	A42DE, A42DL, A43DE, A43DL, A44DE, A44DL, A45DL .....	1	8/81-Up	57004HCF	K4600F/G-LS
004E	A46DE, A46DF .....	1	90-95	57004PF	K4600H-LS
004E	AW55 .....	1	73-Up	57004AF	K4600-LS
004E	AW70, AW71, AW72 (Non Lock-up) (Volvo - Add 29074) .....	1	76-Up	57004CCF	K4600D-LS
004E	AW70L, AW71L, AW72L (Lock-up) .....	1	8/81-Up	57004HCF	K4600F-LS
004E	BW55 (Volvo) .....	1	74-81	57004YF	K4600A-LS
<b>OVERHAUL KITS (W/ RINGS &amp; SEALS)</b>					
002E	A40, A41, A43 .....	1	73-Up	57002AF	K46900
002E	A40D, A42D, A43D, A44D .....	1	76-Up	57002CCF	K46900D
002E	A42DE, A42DL, A43DE, A43DL, A44DE, A44DL, A45DL .....	1	8/81-Up	57002ECF	K46900F
002E	A46DE, A46DF .....	1	90-95	57002ECF	K46900F
002E	AW55 .....	1	73-Up	57002AF	K46900
002E	AW70, AW71, AW72 (Non Lock-up) (Volvo - Add 29074) .....	1	76-Up	57002CCF	K46900D
002E	AW70L, AW71L, AW72L (Lock-up) .....	1	8/81-Up	57002ECF	K46900F
002E	BW55 (Volvo) .....	1	74-81	57002YF	K46900A

ILL.	DESCRIPTION	QTY.	YEAR	PART NO.	REFERENCE NO.
<b>FILTER KITS</b>					
011I	A40, A41, A43, AW55, BW55 .....	1	73-Up	57011A	FK46800
011I	A40D .....	1	76-Up	57011C	FK46800A
011I	A42D, A43D, A44D, AW70, AW71, AW72 .....	1	76-Up	57011D	FK46800D
011I	A42DL, A43DL, A44DL, A45DL, A45DF.....	1	8/81-Up	57011E	FK46800B
011I	A43DE, A44DE, A46DE .....	1	83-Up	57011H	FK46800C
<b>FILTERS (see photos pg 570)</b>					
010I	A40, A41, A43, AW55, BW55 .....	1	73-Up	57010A	46800
010I	A40D .....	1	76-Up	57010C	46800A
010I	A42D, A43D, A44D, AW70, AW71, AW72 .....	1	76-Up	57010D	46800D
010I	A42DL, A43DL, A44DL, A45DL, A45DF.....	1	8/81-Up	57010E	46800B
010I	A43DE, A44DE, A46DE .....	1	83-Up	57010H	46800C
<b>BUSHINGS</b>					
030E	Bushing Kit, A40, A41, A43, AW55.....	1	73-Up	57030A	K46901
030E	Bushing Kit, A40D, A42D Series, AW70.....	1	78-Up	57030D	K46901A
030E	Bushing Kit, A43D, A44D, A45D, A46D Series, AW71.....	1	80-Up	57030DA	K46901B
034A	Pump Body.....	1	73-Up	57034A	46001
036A	Stator (Front & Rear) .848" ID .384" Wide (Babbit).....	1-2	73-Up	57036A	46007
036A	Stator (Front & Rear) .848" ID .680" Wide (Bronze).....	1-2	73-Up	57036C	46007A
040A	Overdrive Drum (Front) (No Groove).....	2	73-Up	57040C	46010
040A	Overdrive Drum (Rear) (w/ Groove).....	2	73-Up	57040J	46010A
042F	Overdrive Planet (Pilot).....	1	73-Up	57042C	46011
044H	Center Support (1.040" Wide).....	1	73-Up	57044A	46004
052D	Sun Gear Shaft (.384" Wide).....	2	73-Up	57036A	46007
052D	Sun Gear Shaft (.680" Wide).....	2	73-Up	57036C	46007A
062I	Output Shaft.....	1	73-Up	57062A	46005
064E	Case (can use 12034).....	1	73-Up	12034	12502
066I	Extension Housing (1.53" OD, 1.37" ID, 1.20" Tall).....	1	73-Up	119066	19002X
066I	Extension Housing (1.53" OD, 1.37" ID, 1.82" Tall) (Isuzu).....	1	81-85	57066AE	46006A
066I	Extension Housing (1.67" OD, 1.49" ID, 1.20" Tall).....	1	73-Up	57066A	46006
066I	Extension Housing (1.67" OD, 1.49" ID, 1.82" Tall) (Isuzu).....	1	86-Up	57066AF	46006B
066I	Extension Housing (1.73" OD, 1.54" ID, 1.37" Tall).....	1	73-Up	57066J	46006C
<b>METAL CLAD SEALS</b>					
070A	Front.....	1	73-Up	57070A	46200B
072I	Linkage.....	2	73-Up	57072A	46202
074I	Rear (38mm x 58mm x 11mm) A40, A41, A43 (Toyota).....	1	73-Up	57074A	42201A
074I	Rear (35mm x 49.2mm x 11mm) A40D, A42D, A43D (Isuzu).....	1	81-85	57074AD	46201
074I	Rear (38.5mm x 49.2mm x 8mm) A42D, A42DL, AW71 (Isuzu).....	1	86-Up	57074D	46201A
074I	Rear (39.5mm x 57.1mm x 13.2mm) A44D, A44DL (Mitsubishi).....	1	73-Up	57074J	46201B
074I	Rear (36mm x 49.5mm x 11mm) AW55, BW55, AW70-72 (Volvo).....	1	73-Up	29074	47201A
078I	Speed-O Shaft (Exc. Volvo).....	1	73-Up	57078A	46203
078I	Speed-O Shaft (Volvo).....	1	81-Up	57078Y	46203A
<b>FRICION PLATES</b>					
100B	Overdrive Brake (.067") (33 T).....	3	82-Up	67100A	75102
100B	Overdrive Brake (.091") (24 T).....	3	73-Up	57102A	46100A
100B	Overdrive Brake (.091") (44 T).....	3	79-81	57102B	46105
102F	Overdrive (Direct).....	1	73-Up	57102AA	46100
104H	Intermediate (Brake #2) (.091").....	2-3	73-Up	57102AA	46100
104H	Intermediate (Brake #2) (.080").....	2-3	85-Up	57102A	46100A
105C	Intermediate Overrun (Brake #1).....	1-3	73-Up	57102AA	46100
106C	Direct.....	3-4	73-Up	57102AA	46100

ILL.	DESCRIPTION	QTY.	YEAR	PART NO.	REFERENCE NO.
<b>FRICION PLATES (Cont.)</b>					
108G	Forward (.080") .....	3-4	81-97	57102A	46100A
108G	Forward (.091") .....	3-4	73-Up	57102AA	46100
114D	Low & Reverse (Brake #3) (16 T).....	4-5	73-Up	57114A	46103
<b>STEEL PLATES</b>					
120B	Overdrive Brake (.071") (8 Short T).....	2-3	77-Up	57122AA	46102
120B	Overdrive Brake (.071") (8 Long T).....	4	81-97	57124AA	46101
120B	Overdrive Brake (.078") (7 T).....	2-3	81-Up	57124D	46107A
120B	Overdrive Brake (.091") (7 T).....	1-3	84-Up	57124E	46107B
120B	Overdrive Brake (.158") (7 T) Mitsubishi.....	3	95-Up	57122G	N/A
122F	Overdrive (Direct) (.055").....	1	90-97	57122Q	46102D
122F	Overdrive (Direct) (.071").....	1-2	77-Up	57122AA	46102
122F	Overdrive (Direct) (.079").....	1	88-97	57122A	46101B
124H	Intermediate (Brake # 2) (.071") (8 Long T) .....	2-4	73-Up	57124AA	46101
124H	Intermediate (Brake # 2) (.078") (8 Short T).....	1-3	80-Up	57124A	N/A
124H	Intermediate (Brake # 2) (.091") (8 T).....	3	74-Up	57124B	46101A
124H	Intermediate (Brake # 2) (.118") (8 T).....	2	85-Up	57124C	46101D
125C	Overrun (Brake # 1) (.071") (8 Long T).....	1-3	73-Up	57124AA	46101
125C	Overrun (Brake # 1) (.078") (8 Short T) .....	1-3	73-Up	57124A	N/A
126C	Direct (.071").....	2-3	73-Up	57122AA	46102
126C	Direct (.078").....	3-4	80-Up	57122A	46101B
126C	Direct (.091").....	AR	73-Up	57122QA	46102B
128G	Forward (.055").....	1-4	81-Up	57122AB	46102A
128G	Forward (.071").....	3-4	73-Up	57122AA	46102
128G	Forward (.078").....	3-4	80-Up	57122A	46101B
128G	Forward (.091").....	AR	73-Up	57122QA	46102B
134D	Low & Reverse (Brake # 3) (Exc. A46DE, DF).....	4	73-Up	57134A	46104
134D	Low & Reverse (Brake # 3) (A46DE, DF).....	4	73-Up	57134Q	N/A
<b>SEALING RINGS</b>					
175E	Ring Kit, A40, A41, A43, AW55, BW55.....	1	73-Up	57175A	K46300H
175E	Ring Kit, A40D to A46DE.....	1	76-Up	57175C	K46300G
175E	Ring Kit, A42D to A45DL.....	1	82-Up	57175H	K46300F
175E	Ring Kit, BW55 .....	1	73-Up	57175Y	K46300A
<b>GASKETS &amp; O-RINGS</b>					
300I	Gasket, Bottom Pan (Cork).....	1	73-Up	57300A	13400X
300I	Gasket, Bottom Pan (Fiber).....	1	73-Up	57300AF	13400F
305I	Gasket, Extension Housing.....	1	73-Up	57305A	13402
311A	D-Ring, Pump (D Ring).....	1	73-79	57311A	13401
311A	O-Ring, Pump (O Ring).....	1	79-Up	57311AA	13401A
311A	O-Ring, Overdrive Housing to Case.....	1	73-Up	57311C	N/A
326I	Filter Gasket, A40, A41, A43, BW55.....	1	73-Up	57326A	13407
326I	Filter Gasket, A40D.....	1	73-Up	57326C	13407A
326I	Filter Gasket, A42D.....	1	73-Up	57326D	13407D
326I	Filter Gasket, A42DL, A43DL.....	1	73-Up	57326E	13407B
326I	Filter Gasket, A43DE.....	1	73-Up	57326H	13407C
<b>TECHNICAL MANUALS</b>					
400E	Tech Manual, A40 Series.....	1	73-Up	57400A	46Y01
<b>ELECTRICAL COMPONENTS</b>					
427	Solenoid, Overdrive A42D, A43D (Mounts on Side of Case).....	1	83-Up	57427P	N/A



# TOYOTA A40 SERIES RWD

# ISUZU, VOLVO, MITSUBISHI

As an additional verification, the Filter Gaskets have been illustrated for each A40 Series model to assist in identification of transmission. Filter Gaskets are included in the Filter Kits.

## A40, A41, A43, AW55, BW55



Filter  
57010A

### A40D



Filter  
57010C

## A42D, A43D, A44D, AW70, AW71



Filter  
57010D

## A43DE, A44DE, A46DE



Filter  
57010H

## A42DL, A43DL, A44DL, A45DL, A45DF



Filter  
57010E



57326C  
A40D



57326D  
A42D, A43D,  
AW70, AW71



57326H  
A43DE, A46DE



57326G  
A42DL, A43DL,  
A44DL, A45DL, A45DF

Toyota transmissions can be identified by two methods. One is by transmission model on the tag, the other by the 3rd digit in the transmission serial number.

**SERIAL NO. IDENTIFICATION**  
(See example below)

First numerical is year of production = 9 is 1979.  
Second letter is month of production = J is October  
Third letter is type of transmission = A is A40

Asian Warner	
<b>TOYOTA</b>	
Model	
Engine	
Trans. Tag.	03-55
Serial No. 3rd Digit	9J (A) XXXXXX

TRANS TAG I.D. IDENTIFICATION	3RD DIGIT SERIAL NO.	TRANSMISSION TYPE
03-50	B	A40D
03-51	B	A40D
03-55	A	A40
03-56	D	A41
03-60	B	A40D
03-70	C	A42D
03-70L	—	A42DL
03-71	F	A43D
03-71L	H	A43DL
03-71LE	L	A43DE
03-72	P	A44D
03-72L	P	A44DL, A45DL
03-75	—	A43
03-72	AW372, KM148	A44D
03-72LE	—	A44DE

### TOYOTA REAR WHEEL DRIVE

MODEL	YEAR	TRANSMISSION	DESCRIPTION
All 3 Speed	8/72-77	A40	3 Speed
Celica	78-80	A40	3 Speed
Celica	1/79-7/85	A40D	4 Speed O.D.
Corolla	78-82	A40	3 Speed
Corolla	82-83	A40D	4 Speed O.D.
Corolla	83-84	A41	3 Speed
Corolla	8/83-Up	A42DL	4 Speed O.D. w/Lock Up
Corona	78-80	A40	3 Speed
Corona	81-82	A40D	4 Speed O.D.
Cressida	78-80	A40D	4 Speed O.D.
Cressida	8/80-8/82	A43D	4 Speed O.D.
Cressida	8/82-7/84	A43DL	4 Speed O.D. w/Lock Up
Cressida	8/84-8/86	A43DE	4 Speed O.D. w/Lock Up & E.C.
Pickups	78-80	A40	3 Speed
Pickups	81-82	A43, A43D	3 & 4 Speed
Pickups	83-Up	A43D	4 Speed O.D.
Supra	1/79-8/80	A40D	4 Speed O.D.
Supra	8/80-7/82	A43D	4 Speed O.D.
Supra	8/82-12/85	A43DL	4 Speed O.D. w/Lock Up
Supra	83-Up	A43DE	4 Speed O.D. w/Lock Up & E.C.
Van	8/83-Up	A44DL	4 Speed O.D. w/Lock Up
Van	87-Up	A45DF	4 Speed - 4WD
Van	87-Up	A45DL	4 Speed - 2 WD
Previa Van	91-Up	A46DE	4 Speed

ISUZU IDENTIFICATION			VOLVO IDENTIFICATION		
Year	Model	Toyota Type	Year	Model	Toyota Type
81-84	I-Mark	A40	73-82	AW55, BW55 - 3 Speed	A40
83-84	Pickup	A40	81-82	AW70 - 4 Speed	A42D
83-84	Impulse	A42D, A43D	81-Up	AW71 - 4 Speed	A43D
85-91	Impulse	A44DL	92-Up	AW70L	A42DL
85-91	Pickups	A44DL	92-Up	AW72L	A43DL
MITSUBISHI IDENTIFICATION					
Year	Model	Toyota Type			
87-Up	D50 Ram Truck				
	- 2WD - AW372	A44D			
87-Up	Raider, Montero				
	- 4WD - KM148	A44D			

# TOYOTA A55 SERIES RWD



257010



257010A

Tercel — 79-86  
All Models w/FWD, 4WD, 3 Speed  
1987-Up Uses A132L. See index.

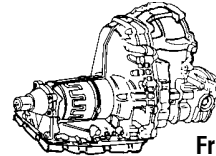

Front Wheel Drive

ILL.	DESCRIPTION	QTY.	YEAR	PART NO.	REFERENCE NO.
<b>MASTER OVERHAUL KITS (WITH STEELS)</b>					
006	A55, A55F .....	1	79-87	257006F	K6200
<b>LESS STEEL KITS</b>					
004	A55, A55F .....	1	79-87	257004F	K6200-LS
<b>OVERHAUL KITS (W/ RINGS &amp; SEALS)</b>					
002	A55, A55F .....	1	79-87	257002F	K62900
<b>FILTERS</b>					
010	2wd .....	1	79-87	257010	62800A
010	4wd .....	1	79-87	257010A	62800B
<b>BUSHINGS</b>					
034	Bushing, Pump .....	1	79-87	57034A	46001
<b>METAL CLAD SEALS</b>					
070	Front Pump .....	1	79-87	57070A	46200B
076	Axle Left & Right .....	2	79-87	257076	62203
<b>FRICITION PLATES</b>					
102	Front & Rear (24 T) .....	4-5	79-87	57102AA	46100
102	Brake #1 & #2 (24 T) .....	3	79-87	57102AA	46100
114	Brake #3 (16 T) .....	4	79-87	57114A	46103
<b>STEEL PLATES</b>					
122	Front & Rear (8 T) .....	6-7	79-87	57122AA	46102
122	Brake #1 & #2 (8 T) .....	4-5	79-87	57122AA	46102
134	Brake #3 (15 T) .....	5	79-87	57134A	46104
<b>MISCELLANEOUS COMPONENTS</b>					
700	Chain .....	1	79-87	257700	62973
300	Gasket, Bottom Pan (Cork) (Fiber = 257300F) .....	1	79-87	257300	13719X
245	Sprag Thrust Plate .....	1	79-87	57245	46504
652	Sprag, Intermediate .....	1	79-87	57652D	46502A
654	Sprag, Low .....	1	79-87	57654A	46503
400	Tech Manual .....	1	79-87	257400	75Y04



**A240 SERIES  
4 SPEED  
UNDERDRIVE**

**A140 SERIES  
4 SPEED  
OVERDRIVE**

**A130 SERIES  
3 SPEED**

**A210  
GM-MX17  
3 SPEED**

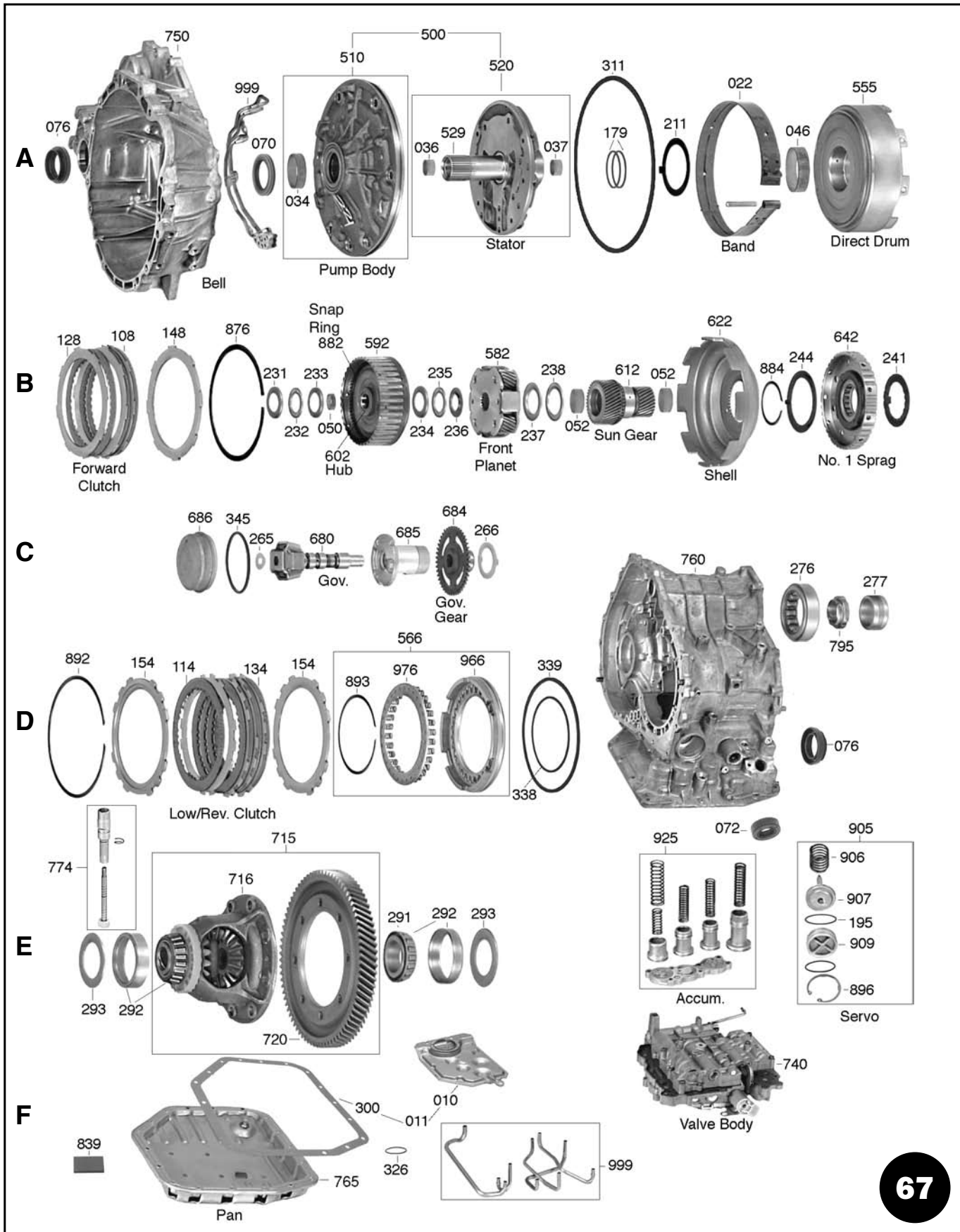

**A210  
GM-MX17  
3 SPEED**

**A130 SERIES  
3 SPEED**

**A140 SERIES  
4 SPEED  
OVERDRIVE**

**A240 SERIES  
4 SPEED  
UNDERDRIVE**

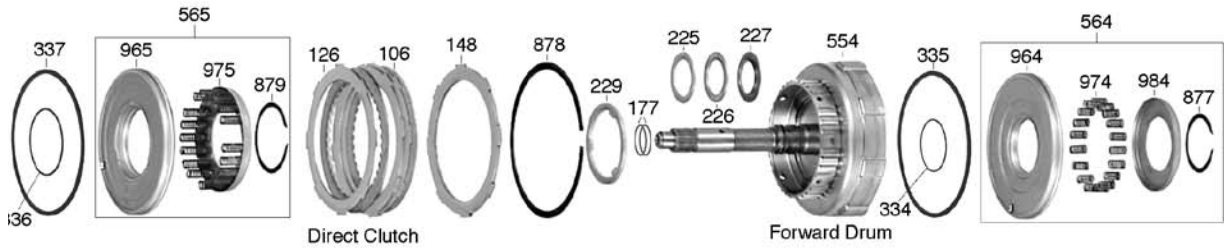

**G**

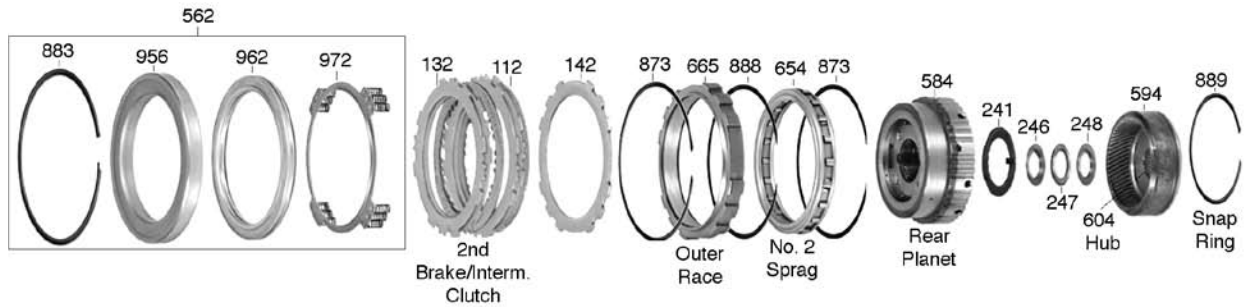

**H**



**I**

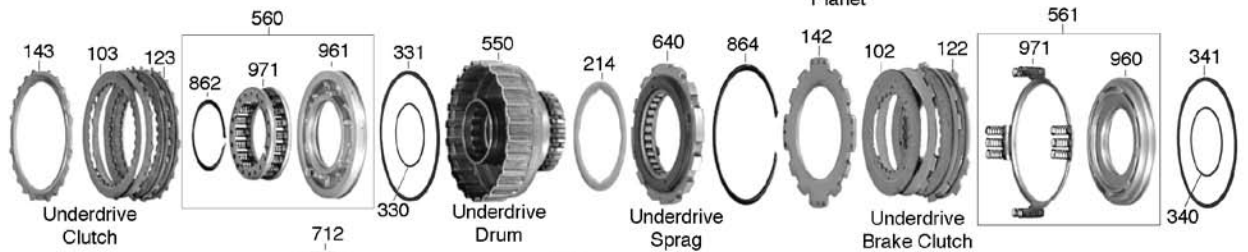

**J**

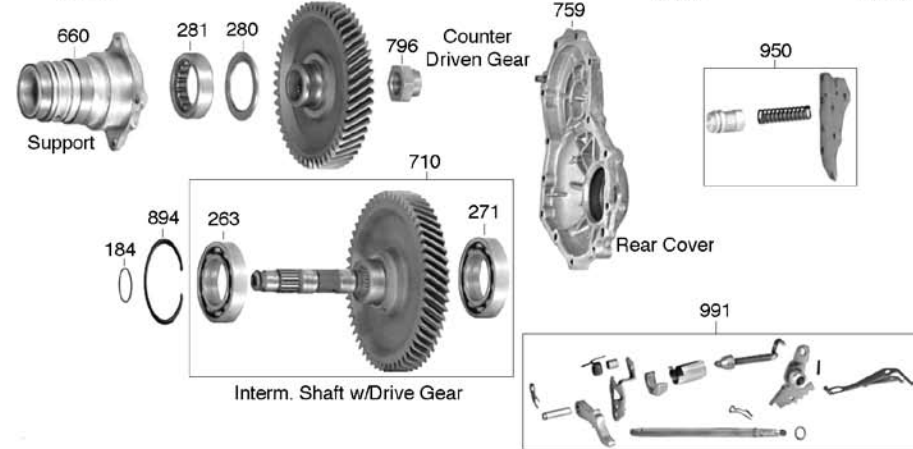

**K**

**L**

Deluxe Kit	008
Compliance Kit	007
Master Kit	006
Less Steel Kit	004
Overhaul Kit	002
Bushing Kit	030
Washer Kit	200
Bearing Kit	201
Technical Manual	400
Pump Part	507
Valve Body Parts	741
Case Parts	761

Note: Not all items are available for all transmissions

**A240 SERIES  
4 SPEED  
UNDERDRIVE**

**A140 SERIES  
4 SPEED  
OVERDRIVE**

**A130 SERIES  
3 SPEED**

**A210  
GM-MX17  
3 SPEED**

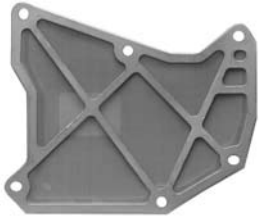

67010A



67010B



67010BA

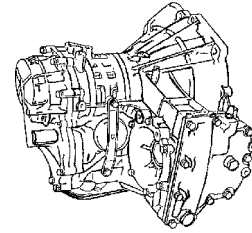

Overdrive (1 Piece Case)



67010D



67010DA



67010DB

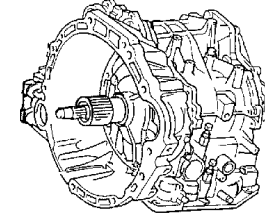

Underdrive (2 Piece Case)

ILL.	DESCRIPTION	QTY.	YEAR	PART NO.	REFERENCE NO.
<b>COMPLIANCE KITS (CALIFORNIA KITS)</b>					
007K	A130, A131, A132 .....	1	83-94	67007BF	CK7500B-R
007K	A140E, A140L, A141E (MR2) .....	1	83-86	67007CF	CK7500-R
007K	A140E, A140L .....	1	87-2/94	67007CAF	CK7500E-R
007K	A240, A241, A242, A243, A244 (A241H also order 87001) .....	1	85-99	67007DF	CK7500D-R
007K	A245E, A246E, A247E .....	1	93-02	67007DAF	CK7500G-R
007K	A245E, A246E .....	1	03-Up	67007EF	CK7500CK-R
007K	MX17 (Exc. Daihatsu) .....	1	85-Up	67007AF	CK7500M-R
<b>MASTER OVERHAUL KITS (WITH STEELS)</b>					
006K	A130, A131, A132 .....	1	83-94	67006BF	K7500B
006K	A132L .....	1	95-Up	67006BBF	N/A
006K	A140E, A140L, A141E (MR2) .....	1	83-86	67006CF	K7500
006K	A140E, A140L .....	1	87-2/94	67006CAF	K7500E
006K	A140E, A140L .....	1	2/94-01	67006CBF	K7500E
006K	A240, A241, A242, A243, A244 (A241H also order 87001) .....	1	85-99	67006DF	K7500D/A
006K	A245E, A246E, A247E .....	1	93-02	67006DAF	K7500G
006K	A245E, A246E .....	1	03-Up	67006EF	K7500K
006K	MX17 (Exc. Daihatsu) .....	1	85-Up	67006AF	K7500M
<b>LESS STEEL KITS</b>					
004K	A130, A131, A132 .....	1	83-94	67004BF	K7500B-LS
004K	A132L .....	1	95-Up	67004BBF	N/A
004K	A140E, A140L, A141E (MR2) .....	1	83-86	67004CF	K7500-LS
004K	A140E, A140L (87-2/94) .....	1	87-E94	67004CAF	K7500E-LS
004K	A140E, A140L (2/94-01) .....	1	L94-01	67004CBF	K7500E-LS
004K	A240, A241, A242, A243, A244 (A241H also order 87001) .....	1	85-99	67004DF	K7500D/A-LS
004K	A245E, A246E, A247E .....	1	93-02	67004DAF	K7500G-LS
004K	A245E, A246E .....	1	03-Up	67004EF	K7500K-LS
004K	MX17 (Exc. Daihatsu) .....	1	85-Up	67004AF	K7500M-LS
<b>OVERHAUL KITS (W/ RINGS &amp; SEALS)</b>					
002K	A130, A131, A132, A132L .....	1	83-Up	67002BF	K75900B
002K	A140E, A140L, A141E (MR2) .....	1	83-Up	67002CF	K75900
002K	A240, A241, A242, A243, A244 (A241H also order 87001) .....	1	85-99	67002DF	K75900A
002K	A245E, A246E, A247E .....	1	93-02	67002DAF	K75900G
002K	A245E, A246E .....	1	03-Up	67002EF	K75900K
002K	MX17 (Exc. Daihatsu) .....	1	85-Up	67002AF	K75900M
002K	MX17 (Daihatsu) .....	1	87-Up	67002ABF	K75900AM

**A210  
GM-MX17  
3 SPEED**

**A130 SERIES  
3 SPEED**

**A140 SERIES  
4 SPEED  
OVERDRIVE**

**A240 SERIES  
4 SPEED  
UNDERDRIVE**

ILL.	DESCRIPTION	QTY.	YEAR	PART NO.	REFERENCE NO.
<b>SUB KITS</b>					
001K	A241H Transfer Case Sub Kit .....	1	88-Up	87001	K75900-5H
<b>FILTER KITS</b>					
011F	A130, A140 (2wd w/ Rectangle Pick-Up Opening 1/2" X 2 1/4") .....	1	83-Up	67011BA	FK75800
011F	A130, A140 (2wd w/ Square Pick-Up Opening 2" X 2 1/4") .....	1	83-Up	67011B	FK75800
011F	A130, A140 (4wd) .....	1	83-Up	67011C	FK75800B
011F	A240, A241, A242, A243, A244 (Exc. A241 Awd) .....	1	85-Up	67011D	FK75800A
011F	A245, A246, A247 .....	1	93-02	67011DA	FK75800C
011F	A245 .....	1	03-Up	67011DB	FK75800E
011F	MX17 (Exc. Daihatsu) .....	1	85-Up	67011A	FK75800M
011F	MX17 (Daihatsu) .....	1	88-91	67011AA	FK75800N
<b>FILTERS</b>					
010F	A130, A140 (2wd w/ Rectangle Pick-Up Opening 1/2" X 2 1/4") .....	1	83-Up	67010B	75800
010F	A130, A140 (2wd w/ Square Pick-Up Opening 2" X 2 1/4") .....	1	83-Up	67010BA	75800
010F	A240, A241, A242, A243, A244 (Exc. A241 Awd) .....	1	85-Up	67010D	75800A
010F	A245, A246, A247 .....	1	93-02	67010DA	75800C
010F	A245 .....	1	03-Up	67010DB	75800E
010F	MX17 (Exc. Daihatsu) .....	1	85-Up	67010A	75800M
010F	MX17 (Daihatsu) .....	1	88-91	67010AA	75800N
<b>BANDS</b>					
Prefix Key: B = Borg Warner, A = OEM (Exc. BW), N = All Other New, R = Relined					
022A	Band (1" Wide) (A130, A140, A240) .....	1	83-Up	67022B	75700
022A	Band (1 1/4" Wide) (MX17) .....	1	85-Up	67022A	75700M
<b>BUSHINGS</b>					
030K	Bushing Kit (A130) .....	1	83-Up	67030B	K75901
030K	Bushing Kit (A140) .....	1	83-Up	67030C	K75901A
030K	Bushing Kit (A240) .....	1	85-Up	67030B	K75901B
030K	Bushing Kit (MX17) (67046AA Not Included) .....	1	85-Up	67030B	K75901
034A	Pump Body (All) .....	1	83-Up	57034A	46001
036A	Stator (Front) (All) .....	1	83-Up	57036C	46007A
037A	Stator (Rear) (All) .....	1	83-Up	67037A	75003
038	Overdrive Sun Gear, A140 (Front) .....	1	83-Up	67038C	75008
038	Overdrive Sun Gear, A140 (Rear) .....	1	83-Up	67038CA	75007
046A	Direct Drum (1.855" ID) .....	1	83-Up	67046A	75005
046A	Direct Drum (2.030" ID) .....	1	87-Up	67046AA	75005B
050B	Input Hub (All) .....	1	83-Up	67050B	75006
052B	Sun Gear (All) .....	2	83-Up	67052A	75004
<b>METAL CLAD SEALS</b>					
070A	Pump (All) .....	1	83-Up	57070A	46200B
072D	Linkage (All) .....	1	83-Up	57072A	50203
076D	Transfer Shaft Seal (All Exc A240E/L) .....	2	83-Up	67076BB	75203
076D	Axle, Right (2.137" OD) (A141E, A240-246 33 x 54mm) .....	1	83-Up	67076B	75201B
076D	Axle, Right (2.145" OD) (A131L, A132L) .....	1	83-Up	67076A	75201M
076D	Axle, Right (2.180" OD) (A130L, A140E/L, A240-246 35 x 55mm) .....	1	83-Up	67076BA	75201A
076D	Axle, Right (2.492" OD) (A240-246 33 x 54mm) .....	1	83-Up	67076BC	75201C
077	Axle, Left (A130L) .....	1	83-Up	67076BA	75201A
077	Axle, Left (A131L, A132L) (3/98-Up) .....	1	98-Up	67077	89201M
077	Axle, Left (A131L, A132L) (83-2/98) .....	1	83-2/98	67076B	75201B
077	Axle, Left (A140, A240) (1.898" OD) .....	1	83-Up	67076BB	75203
077	Axle, Left (A140, A240) (2.137" OD) .....	1	83-Up	67076B	75201B
077	Axle, Left (A140, A240) (2.180" OD) .....	1	83-Up	67076BA	75201A

A130/140/240

**A240 SERIES  
4 SPEED  
UNDERDRIVE**

**A140 SERIES  
4 SPEED  
OVERDRIVE**

**A130 SERIES  
3 SPEED**

**A210  
GM-MX17  
3 SPEED**

ILL.	DESCRIPTION	QTY.	YEAR	PART NO.	REFERENCE NO.
<b>METAL CLAD SEALS (Cont.)</b>					
077	Axle, Left (A140, A240) (2.492" OD).....	1	83-Up	67076BC	75201C
077	Axle, Left (A241, 243, 247).....	1	85-Up	67076BD	75201H
077	Axle, Left (Awd) (A241) .....	1	85-Up	67077D	75201F
077	Axle, Left (MX17) .....	2	83-Up	67076A	75201M
078	Speed-O-Gear (All).....	1	83-Up	57078A	46203
<b>FRICTION PLATES</b>					
100	Overdrive Brake (.067") (33 T) .....	3	83-7/86	67100A	75102
100	Overdrive Brake (.075") (24 T) .....	3	8/86-Up	67100C	75102B
102J	Overdrive Direct (.067") (40 T) .....	2	83-7/86	67106A	75100B
102J	Overdrive Direct (.075") (40 T) .....	2	8/86-Up	67106C	75100C
102J	Underdrive #2 Brake (.067") (33 T) (A240, A241, A242, A243, A244) .....	3	85-Up	67102D	75106A
102J	Underdrive #2 Brake (.067") (33 T) (A245, A246, A247) .....	3	93-Up	67102DA	75106B
103J	Underdrive #1 Direct (.075") (34 T) .....	3-4	85-Up	67103C	75106
106G	Direct (.067") .....	2-3	83-Up	67106A	75100B
106G	Direct (.075") .....	2-4	83-Up	67106C	75100C
108B	Forward (.067") .....	3-4	83-Up	67106A	75100B
112H	2nd Brake (Coast) (.067") .....	3	83-Up	67100A	75102
112H	2nd Brake (Coast) (.075") .....	2-3	83-Up	67100CA	75102A
114D	3rd Brake (Low & Reverse) (.059") (33 T) (Exc. A245, A246, A247).....	6	93-Up	67100B	75102C
114D	3rd Brake (Low & Reverse) (.067") (33 T) (Exc. A245, A246, A247).....	4-6	83-Up	67100A	75102
114D	3rd Brake (Low & Reverse) (.069") (33 T) (A245, A246, A247) .....	5-6	93-Up	67100D	75102J
118	Differential (.075") (34 T) .....	7	88-92	67103C	75106
<b>STEEL PLATES</b>					
120	Overdrive Brake (.071") .....	3	83-7/86	67120C	75105
120	Overdrive Brake (.075") .....	3	8/86-Up	67120CA	75105A
120	Overdrive Brake (.098") .....	3	88-Up	67120CB	75105B
122J	Overdrive Direct (8 T) .....	2	83-7/86	67122A	75101
122J	Overdrive Direct (20 T) .....	2	8/86-Up	67122C	75101A
122J	Underdrive #2 Brake (3.150" ID).....	3	83-Up	67122D	75107A
122J	Underdrive #2 Brake (3.425" ID).....	3	93-Up	67122DA	75107B
123J	Underdrive #1 Direct .....	3-4	85-Up	67121D	75107
126G	Direct.....	2-3	83-Up	67122A	75101
128B	Forward .....	3-4	83-Up	67122A	75101
132H	2nd Brake (Coast) .....	3-4	83-Up	67120B	75105B
134D	3rd Brake (Low & Reverse) (12 T).....	5-8	83-Up	67120C	75105
134D	3rd Brake (Low & Reverse) (33 T).....	6	93-Up	67130D	75105C
138	Differential .....	8	88-92	67121D	75107
<b>PRESSURE PLATES</b>					
<b>Prefix Key: D = OEM, A = Aftermarket New, R = Remanufactured</b>					
148B	Forward & Direct (2.60mm) .....	1-2	83-Up	67146AB	75515C
148B	Forward & Direct (3.00mm) .....	1-2	83-Up	67146AA	75515B
148B	Forward & Direct (3.37mm) .....	1-2	83-Up	67146A	75515D
<b>VALVE BODY RECALIBRATION KITS</b>					
165	Reprogramming Kit™ (A245E) (Transgo®).....	1	83-Up	T67169D	A245E-HD
<b>SEALING RINGS</b>					
175K	Ring Kit (A130) .....	1	83-Up	67175B	K75300B
175K	Ring Kit (A140) .....	1	83-Up	67175C	K75300C
175K	Ring Kit (A240) .....	1	85-Up	67175C	K75300C

**A210  
GM-MX17  
3 SPEED**

**A130 SERIES  
3 SPEED**

**A140 SERIES  
4 SPEED  
OVERDRIVE**

**A240 SERIES  
4 SPEED  
UNDERDRIVE**

ILL.	DESCRIPTION	QTY.	YEAR	PART NO.	REFERENCE NO.
<b>THRUST WASHERS</b>					
200K	Washer Kit (A130) .....	1	83-Up	67200B	K75400
200K	Washer Kit (A140) .....	1	83-Up	67200C	K75400A
200K	Washer Kit (A240) .....	1	83-Up	67200D	K75400B
200K	Washer Kit (MX17, A210).....	1	83-Up	67200A	K75400M
211A	Stator to Direct Drum (Exc. 87-Up MX17).....	1	83-Up	67211AA	75404
211A	Stator to Direct Drum (87-Up MX17) .....	1	87-Up	67211A	75404A
217	Overdrive Planet, Bronze (.060").....	1	83-Up	67217A	75932
217	Overdrive Planet, Bronze (.110").....	1	83-Up	57217	75932B
229G	Direct Drum to Fwd Drum (Exc. 87-Up MX17) .....	1	83-Up	67229A	75405
229G	Direct Drum to Fwd Drum (87-Up MX17) .....	1	87-Up	67229AA	75405B
241B	Rear Planet to Rear Ring Gear Hub (Plastic).....	1	83-Up	67241A	75401
244B	Shell to Sprag (2 3/4" OD) (Plastic).....	1	83-Up	67244A	75402
<b>BEARINGS &amp; RACES</b>					
219	Race, Overdrive Drum to Case Cover (Front).....	1	83-86	67219C	75934
219	Bearing w/ Race, Overdrive Drum to Cover .....	1	83-Up	67219CA	N/A
220	Bearing, Overdrive Drum to Case Cover .....	1	83-86	67220C	75938
221	Race, Overdrive Drum to Case Cover (Rear) .....	1	83-Up	67221C	75936
226G	Bearing, Stator to Forward Drum .....	1	83-Up	67226A	N/A
235B	Bearing, Forward Hub to Front Planet (A245, A246, A247).....	1	93-Up	67235D	N/A
236B	Race, Forward Hub to Front Planet (Rear) .....	1	83-Up	67236A	N/A
236B	Race, Forward Hub to Front Planet (Rear) .....	1	85-Up	67236A	N/A
274	Bearing w/ Race, Differential Drive Pinion Cone (Front) (18 Rollers) .....	1	83-Up	87274B	N/A
274	Bearing w/ Race, Pinion (20 Rollers) .....	1	83-Up	67274BA	N/A
274	Bearing w/ Race, Pinion (21 Rollers) .....	1	83-Up	67274BB	N/A
281K	Bearing, Transfer Driven (A130, A140) .....	1	83-Up	67281B	N/A
292E	Bearing, Differential (A130 Corolla Gas) (Both Sides).....	2	83-Up	67292B	N/A
289	Bearing, Differential (A140 Ring Gear Side).....	1	83-Up	67289CA	N/A
292	Bearing, Differential (A140 Speed-O Side) (87-Up) .....	1	87-Up	67292CB	N/A
<b>GASKETS &amp; O-RINGS</b>					
300F	Gasket, Bottom Pan (A130, A140) (Cork) .....	1	83-Up	67300B	13470X
300F	Gasket, Bottom Pan (A130, A140) (Fiber).....	1	83-Up	67300BF	13470F
300F	Gasket, Bottom Pan (A240, A241, A242, A243, A244) (Cork).....	1	85-99	67300D	13470AX
300F	Gasket, Bottom Pan (A240, A241, A242, A243, A244) (Fiber) .....	1	85-99	67300DF	13470AF
300F	Gasket, Bottom Pan (A245E, A246E, A247E) (Cork).....	1	93-02	67300DA	13470CX
300F	Gasket, Bottom Pan (A245E, A246E, A247E) (Fiber).....	1	93-02	67300DAF	13470CF
300F	Gasket, Bottom Pan (A245E, A246E) (Cork) .....	1	03-Up	67300E	13470EX
300F	Gasket, Bottom Pan (A245E, A246E) (Fiber).....	1	03-Up	67300EF	13470EF
300F	Gasket, Bottom Pan (MX17) (Cork) .....	1	85-Up	67300A	13950X
300F	Gasket, Bottom Pan (MX17) (Fiber) .....	1	85-Up	67300AF	13950F
303	Gasket, Differential Cover .....	1	83-Up	67303B	N/A
303	Gasket, Differential Cover (A130L, A140) .....	1	83-Up	67303B	N/A
303	Gasket, Differential Cover (A131L).....	1	83-Up	67303BA	N/A
303	Gasket, Differential Cover (A132L).....	1	83-Up	67303BB	N/A
304	Gasket, Overdrive Cover (A140) .....	1	83-Up	67304C	N/A
311A	O-Ring, Pump (All).....	1	83-Up	67311B	13471
326	Gasket, Filter (A130, A140) .....	1	83-Up	67326B	13474
326	Gasket, Filter (A240 to A244E) .....	1	85-Up	67326D	13474A
<b>TECHNICAL MANUALS</b>					
400K	Tech Manual (A140).....	1	83-Up	67400C	75Y02
400K	Tech Manual, Fwd (OEM) .....	1	83-Up	67400FWD	75Y04
400K	Tech Manual (MX17) .....	1	85-Up	67400A	75Y05

A130/140/240

**A240 SERIES  
4 SPEED  
UNDERDRIVE**

**A140 SERIES  
4 SPEED  
OVERDRIVE**

**A130 SERIES  
3 SPEED**

**A210  
GM-MX17  
3 SPEED**

ILL.	DESCRIPTION	QTY.	YEAR	PART NO.	REFERENCE NO.
<b>ELECTRICAL COMPONENTS</b>					
420	Solenoid Kit (Shift) (A140, A240, A241, A242, A243, A244) .....	1	83-Up	67420CK	31R-401
420	Solenoid Kit (Shift) (A245, A246, A247) .....	1	93-Up	67420DAK	N/A
420	Solenoid Kit (Shift & Lock-Up) (A240, A241, A242, A243, A244) .....	1	85-Up	67420DK	31R-401C
420	Solenoid Kit (Shift & Lock-Up) (A245, A246, A247) .....	1	93-Up	67420DBK	31R-403
420	Solenoid Kit (MX17) .....	1	85-Up	67421AK	31R-190
421	Solenoid, 1-2 Shift (A140) (1 Bolt Triangle Type) .....	1	83-Up	67421C	5A-401
422	Solenoid, 2-3 Shift (A140) (2 Bolt L Shaped Type) .....	1	83-Up	67422C	5A-401A
421	Solenoid, Shift (A240) .....	1	85-Up	67421D	N/A
421	Solenoid, Shift (MX17) (1 Solenoid, Break-off Bracket) .....	2	85-Up	67421A	N/A
421	Solenoid, 2nd Brake (MX17) .....	1	85-Up	67421D	5A-191
422	Solenoid, Direct (MX17) .....	1	85-Up	67422B	5A-190
423	Solenoid, Overdrive Cancel (A240) .....	1	85-Up	67423D	5R-406
425	Solenoid, Lock-Up (TCC) (A240, A241, A242, A243, A244) .....	1	85-Up	67425D	N/A
425	Solenoid, Lock-Up (TCC) (A245, A246, A247) .....	1	93-Up	67425DA	N/A
445	Repair Kit, External Wire Harness (5 Plug-in, Fits 5 Prong Connector) .....	1	83-Up	67445CEAK	N/A
445	Repair Kit, External Wire Harness (5 Prong) .....	1	83-Up	67445CEK	N/A
<b>HARD PARTS</b>					
<b>Prefix Key: D = OEM, A = Aftermarket New, R = Remanufactured</b>					
<b>PUMPS</b>					
500A	Pump Complete (A130) (Toyota Built) .....	1	83-Up	67500B	75920
500A	Pump Complete (A140) (Toyota Built) .....	1	L84-Up	67500B	75920
500A	Pump Complete (A240) .....	1	85-86	67500A	N/A
500A	Pump Complete (A240) .....	1	87-Up	67500AA	72920B
500A	Pump Complete (MX17) .....	1	85-86	67500A	N/A
500A	Pump Complete (MX17) .....	1	87-Up	67500AA	N/A
529A	Stator Shaft Tube (All) .....	1	83-Up	67529A	75969
<b>DRUMS &amp; CLUTCH HUBS</b>					
554G	Forward w/ Shaft (3 Clutch) .....	1	2/84-Up	67554A	75922
554G	Forward w/ Shaft (4 Clutch) .....	1	2/84-Up	67554C	75922A
555A	Direct (2 Clutch) (Exc. MX17) .....	1	2/84-Up	67555BB	75921
555A	Direct (3 Clutch) (Exc. MX17) .....	1	2/84-Up	67555CA	75921A
<b>PLANETS</b>					
580	Overdrive w/ Shaft .....	1	83-85	67580C	K75950
580	Overdrive w/ Shaft (11 Bolt) .....	1	86-91	67580CA	K75950A
580	Overdrive w/ Shaft (12 Bolt) .....	1	92-Up	67580DK	K75950B
582B	Front .....	1	83-Up	67582A	75925
584H	Rear .....	1	83-Up	67584A	N/A
<b>SUN GEARS, SHELLS &amp; SUPPORTS</b>					
612B	Sun Gear, Front Planet (Exc. MX17) .....	1	83-Up	67612B	N/A
612B	Sun Gear, Front Planet (MX17) .....	1	83-Up	67612A	N/A
616I	Sun Gear, Underdrive Planet .....	1	85-Up	67616D	N/A
622B	Shell .....	1	83-Up	67622A	N/A
<b>SPRAGS</b>					
640J	Sprag Assembly, Underdrive (A240) .....	1	85-Up	67640D	75960
650H	Sprag, Overdrive .....	1	83-Up	67650C	75929
652B	Sprag, Intermediate .....	1	83-Up	57652D	46502A
654H	Sprag, Low .....	1	83-Up	67654A	75926

**A210  
GM-MX17  
3 SPEED**

**A130 SERIES  
3 SPEED**

**A140 SERIES  
4 SPEED  
OVERDRIVE**

**A240 SERIES  
4 SPEED  
UNDERDRIVE**

ILL.	DESCRIPTION	QTY.	YEAR	PART NO.	REFERENCE NO.
<b>GOVERNORS</b>					
680C	Governor (Gear Type) (A130, A140) .....	1	83-Up	67680B	75974
680C	Governor (Gear Type) (w/o Gear) (A240) .....	1	85-Up	67680D	N/A
685C	Support Sleeve, Governor (A130) .....	1	85-Up	67685	75945
696	Crush Sleeve (For Pinion) (A130, A140) .....	1	83-Up	67696B	75943
696	Crush Sleeve (For Pinion) (A240) .....	1	83-Up	67696A	75943A
696	Crush Sleeve (For Pinion) (A245, A246) .....	1	83-Up	67696D	75943D
<b>DIFFERENTIALS</b>					
715E	(17 T, 69 T) (5 Groove) (A130) .....	1	83-Up	67715BN	K75972E
715E	(18 T, 67 T) (3 Groove) (A130) .....	1	83-Up	67715BE	K75972A
715E	(19 T, 65 T) (1 Groove) (A130) .....	1	83-Up	67715B	K75972B
715E	(19 T, 67 T) (2 Groove) (A130) .....	1	83-Up	67715BD	K75972
715E	(19 T, 69 T) (5 Groove) (A130) .....	1	83-Up	67715BN	K75972C
715E	(18 T, 71 T, 4 Groove) (A140) .....	1	83-Up	67715BY	N/A
	(22 Rollers on Bearing on Ring Gear Side, 1.575" ID of Bearing) .....				
715E	(18 T, 71 T, 4 Groove) (A140) .....	1	83-Up	67715BX	K75972F
	(23 Rollers on Bearing on Ring Gear Side, 1.732" ID of Bearing) .....				
715E	(19 T, 71 T, 3 Groove) (A140) (1 by Housing, 2 by Bearing) .....	1	83-Up	67715BM	K72972H
	(22 Roller Bearing by Ring Gear, 1.575" ID) Tan Spd-O-Gear .....				
715E	(19 T, 71 T, 3 Groove) (A140) (1 by Housing, 2 by Bearing) .....	1	83-Up	67715BQ	K75972J
	(23 Roller Bearing by Ring Gear, 1.732" ID) Black Spd-O-Gear .....				
715E	(20 T, 68 T, 1 Groove In Center) (A140) .....	1	83-Up	67715BJ	N/A
	(20 Roller Brg by Spd-O-Gear, 23 Roller Brg by Ring Gear) .....				
715E	(20 T, 68 T, 1 Groove In Center) (A140) .....	1	83-Up	67715BL	K75972G
	(24 Roller Brg by Spd-O-Gear, 22 Roller Brg by Ring Gear) .....				
730E	Ring & Pinion Set, w/ Blue Speed-O/Governor Gear .....	1	83-Up	67730BAK	N/A
730E	Ring & Pinion Set (19 T, 2 Groove) (A130, A140) .....	1	83-Up	67730BFB	N/A
735E	Pinion Retainer (Aluminum w/ Seal) (A130, A140) .....	1	83-Up	67735B	N/A
736E	Pinion Center (Aluminum 1 Bolt, 1.020" OD) (A130, A140) .....	1	83-Up	67736B	N/A
<b>VALVE BODIES</b>					
740E	Valve Body (A130 Non Lock-up) (Has a Alum Rod In L-Up Valve Bore) .....	1	83-Up	67740B	N/A
740E	Valve Body (A130 Lock-up) (Has Valve & Spring In L-Up Valve Bore) .....	1	83-Up	67740BA	N/A
740E	Valve Body (A140) (No Solenoids) .....	1	83-Up	67740C	N/A
740E	Valve Body (A140) (w/ 2 Solenoids) .....	1	83-Up	67740CA	N/A
740E	Valve Body (A240) (w/ 1 Solenoids) .....	1	85-Up	67740DC	N/A
740E	Valve Body (A240) (w/ 2 Solenoids) .....	1	85-Up	67740D	N/A
740E	Valve Body (A240) (w/ 3 Solenoids) .....	1	85-Up	67740DA	N/A
740D	Valve Body (MX17) .....	1	85-Up	67740A	N/A
741K	Pressure Regulator Valve Kit (A140, A240) (req T-89010-TL) .....	1	83-Up	67741P	K75882
741K	Pressure Boost Valve & Sleeve (.565" Large Spool) .....	1	83-Up	67741F	K75976
741K	Pressure Boost Valve & Sleeve (.583" Large Spool) .....	1	83-Up	67741FA	K75976A
<b>MISCELLANEOUS COMPONENTS</b>					
775	Bolt, Converter (8mm x 1.25" x 10mm) .....	6	83-Up	67775	N/A
795	Nut, Transfer Shaft (A130, A140) .....	1	85-Up	67795D	75944

A130/140/240





# TOYOTA A440F, A442F, LANDCRUISER

# RWD - 4 SPEED w/OVERDRIVE

ILL.	DESCRIPTION	QTY.	YEAR	PART NO.	REFERENCE NO.
<b>MASTER OVERHAUL KITS (WITH STEELS)</b>					
006	A440F w/ Transfer Case Parts (includes 137001) .....	1	85-92	137006AF	K5900
006	A442F w/o Transfer Case Parts .....	1	93-95	137006DF	K5900A
<b>LESS STEEL KITS</b>					
004	A440F w/ Transfer Case Parts (includes 137001) .....	1	85-92	137004AF	K5900-LS
004	A442F w/o Transfer Case Parts .....	1	93-95	137004DF	K5900A-LS
<b>OVERHAUL KITS (W/ RINGS &amp; SEALS)</b>					
002	A440F w/ Transfer Case Parts (includes 137001) .....	1	85-1/90	137002AF	N/A
002	A440F w/o Transfer Case Parts (does not include 137001) .....	1	85-95	137002F	K55900
002	A442F w/o Transfer Case Parts .....	1	93-95	137002F	K55900
001	Sub Kit, Transfer Case Parts Only A440F (1985-1/90) .....	AR	85-1/90	137001	K59900T
<b>FILTERS &amp; FILTER KITS</b>					
011	Filter Kit, A440F (5/8" Thick) .....	1	85-92	137011	FK59800
011	Filter Kit, A440F (2" Thick) .....	1	85-92	137011A	FK59800A
011	Filter Kit, A442F .....	1	93-95	137011B	FK59800B
010	Filter, A440F (5/8" Thick) .....	1	85-92	137010	59800
010	Filter, A440F (2" Thick) .....	1	85-92	137010A	59800A
010	Filter, A442F .....	1	93-95	137010B	59800B
<b>BUSHINGS &amp; SEALS</b>					
034	Bushing, Pump Body .....	1	85-95	137034A	59001
070	Seal, Front Pump .....	1	85-95	137070	59200B
074	Seal, Adapter Housing .....	1	85-95	137074	59205
<b>FRICITION PLATES</b>					
100	Overdrive Brake (70 T) & 2nd Brake (Intermediate) .....	7-8	85-95	137100	59101
100	Overdrive Brake (75 T) .....	3	93-95	137100A	59101A
102	Overdrive Direct (46 T), Direct (Rear) & Forward (Front) .....	14-15	85-95	137102	59100
114	Low & Reverse .....	6	85-95	137114	59102
<b>STEEL PLATES</b>					
120	Overdrive Brake (.078") .....	3	93-95	137120A	59105C
120	Overdrive Brake (.095") .....	3	85-92	137120	59105
120	Overdrive Brake (.095") .....	3	93-95	137120AA	59105A
120	Overdrive Brake (.157") .....	1	93-95	137120AB	59105B
122	Overdrive Direct (.071") .....	3	85-95	137122	59104
124	2nd Brake (Intermediate) (.078") .....	4	91-95	137120A	59105C
124	2nd Brake (Intermediate) (.095") .....	4	85-90	137120	59105
128	Forward (Front) (.071") & Direct (Rear) .....	11-13	85-95	137122	59104
128	Forward (Front) (.095") .....	1	85-95	137122AB	59104C
134	Low & Reverse (.071") .....	6	85-92	137134	59106
134	Low & Reverse (.095") .....	6	93-95	137134A	59106A
<b>MISCELLANEOUS COMPONENTS</b>					
300	Gasket, Bottom Pan (Cork) .....	1	85-95	137300	13880X
300	Gasket, Bottom Pan (Fiber) .....	1	85-95	137300F	13880F
304	Gasket, Transfer Case .....	1	85-95	137304	13881
310	Gasket, Pump .....	1	85-95	137310A	13878
311	O-Ring, Pump .....	1	85-95	137311A	13879
326	Gasket, Filter (A440F) .....	1	85-95	137326	13882
326	Gasket, Filter (A442F) .....	1	85-95	137326A	13882A
642	Sprag, Low .....	1	85-95	137642	59960
650	Sprag, Overdrive .....	1	85-95	137650	59940

TOYOTA A440F

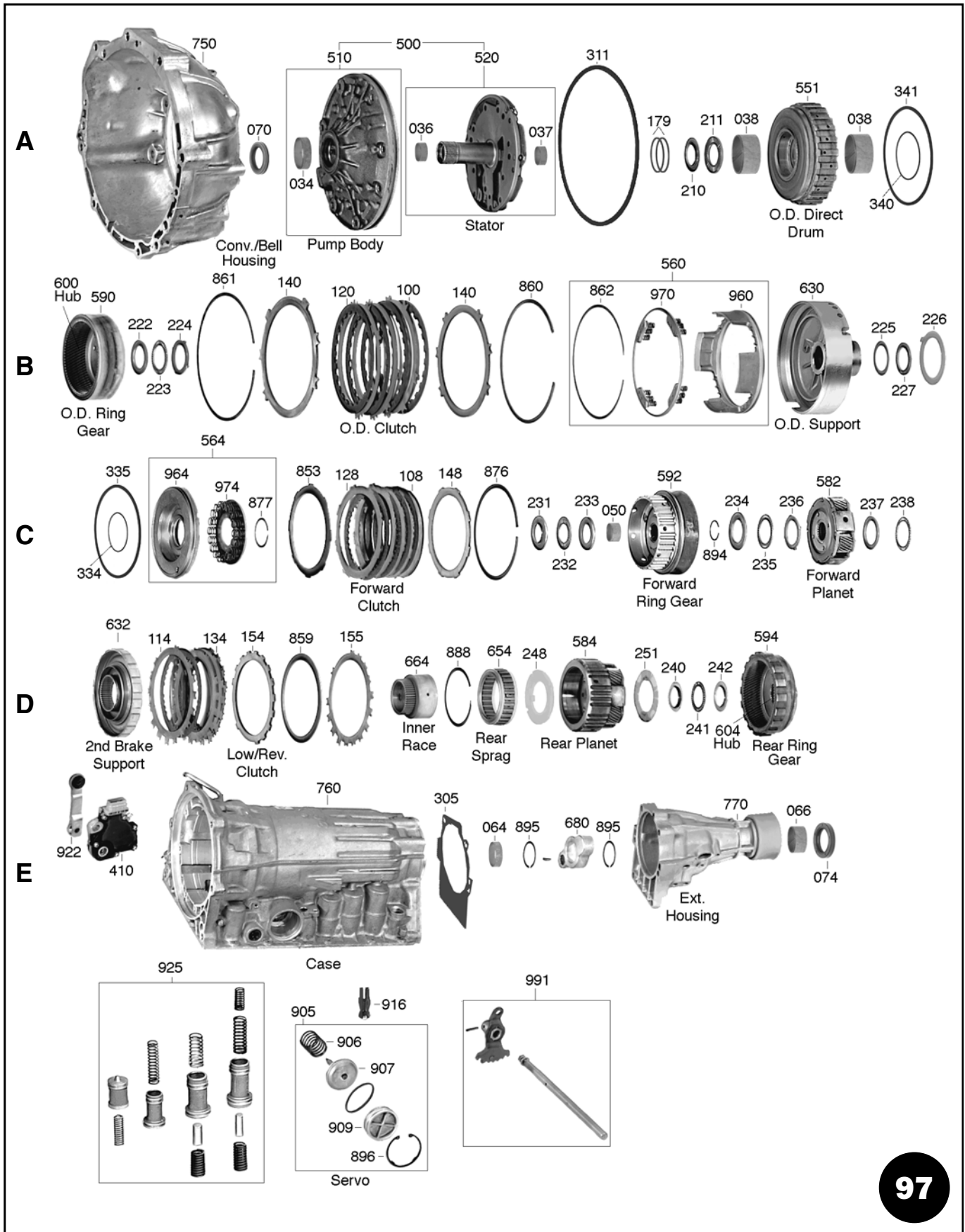

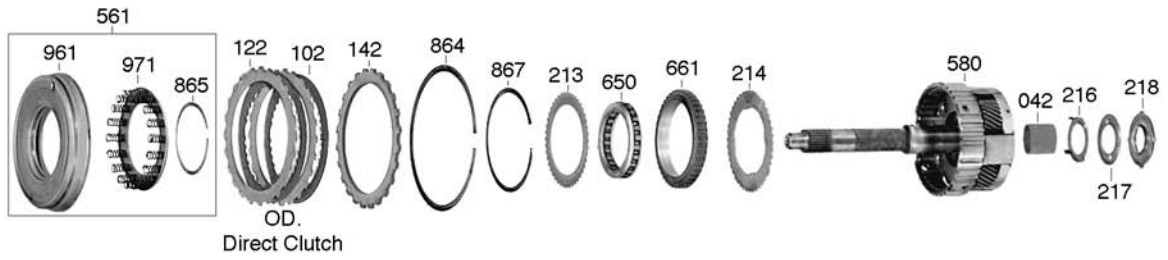

F

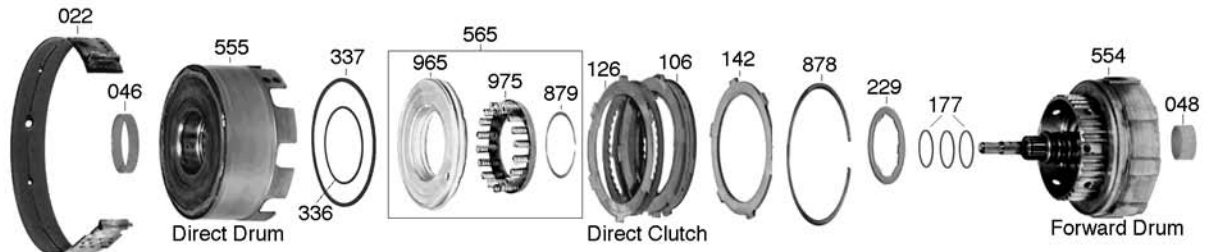

G

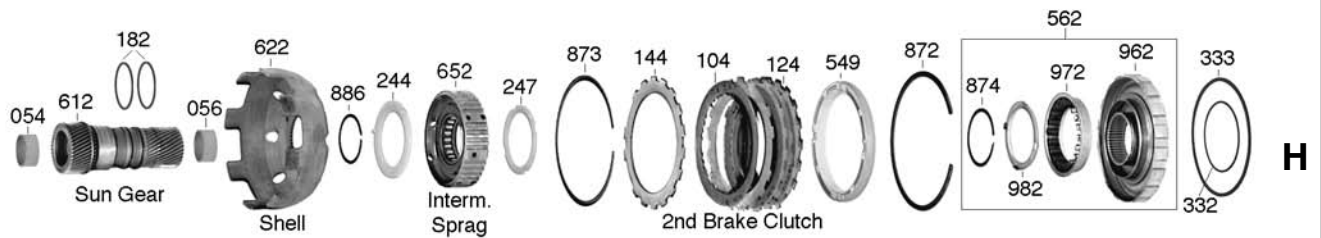

H

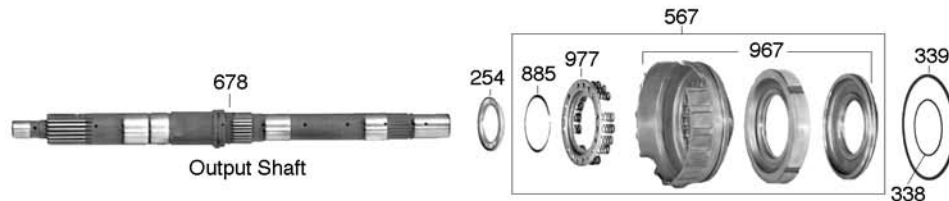

I

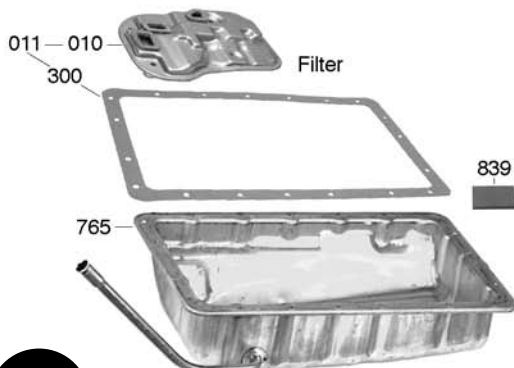
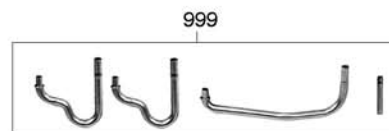
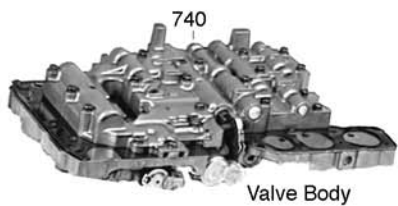

Deluxe Kit	008
Compliance Kit	007
Master Kit	006
Less Steel Kit	004
Overhaul Kit	002
Bushing Kit	030
Washer Kit	200
Bearing Kit	201
Technical Manual	400
Pump Part	507
Valve Body Parts	741
Case Parts	761
Note: Not all items are available for all transmissions	

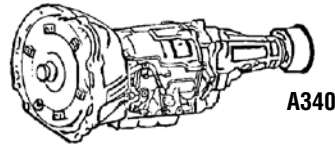

A340

ILL.	DESCRIPTION	QTY.	YEAR	PART NO.	REFERENCE NO.
<b>MASTER OVERHAUL KITS (WITH STEELS)</b>					
006I	A340E, A340H (Toyota) .....	1	85-99	97006F	K5400
006I	A340E, A340H (T-100, Tacoma Truck) .....	1	92-99	97006DF	N/A
006I	A340E, A340F (Toyota) (4 Cyl.) .....	1	95-99	97006EF	N/A
006I	A340E, A340F (Toyota) (Exc. 4 Cyl.) .....	1	00-Up	97006J	K5400F
006I	A340E, A340F (Toyota) (4 Cyl.) .....	1	00-Up	97006K	K5400F
006I	A341E (Lexus, Volvo) .....	1	90-00	97006CF	K5400B
006I	A343F (Landcruiser, Lexus LX450, LX470) .....	1	95-99	97006G	K5400E
006I	A343F (Landcruiser, Lexus) .....	1	00-Up	97006J	K5400G
006I	AW4 (Jeep) .....	1	87-01	97006AF	K5400A
006	A350 (Lexus GS300) .....	1	96-98	97006H	K5400C
006	R150F Transfer Case .....	1	85-Up	197006	K5400T
<b>LESS STEEL KITS</b>					
004I	A340E, A340H (Toyota) .....	1	85-99	97004F	K5400-LS
004I	A340E, A340H (T-100, Tacoma Truck) .....	1	92-99	97004DF	N/A
004I	A340E, A340F (Toyota) .....	1	95-99	97004EF	N/A
004I	A340E, A340F (Toyota) (Exc. 4 Cyl.) .....	1	00-Up	97004J	K5400F-LS
004I	A340E, A340F (Toyota) (4 Cyl.) .....	1	00-Up	97004K	K5400F-LS
004I	A341E (Lexus, Volvo) .....	1	90-00	97004CF	K5400B-LS
004I	A343F (Lexus, Landcruiser) .....	1	95-99	97004G	K5400E-LS
004I	A343F (Lexus, Landcruiser) .....	1	00-Up	97004J	K5400G-LS
004I	AW4 (Jeep) .....	1	87-01	97004AF	K5400A-LS
004	A350 .....	1	96-98	97004H	K5400C-LS
004	R150F Transfer Case .....	1	85-Up	197004	K5400T-LS
<b>OVERHAUL KITS (W/ RINGS &amp; SEALS)</b>					
002I	A340E, A340H (Toyota) .....	1	85-99	97002F	K54900
002I	A340E, A340F (Toyota) .....	1	00-Up	97002J	K54900F
002I	A341E (Lexus, Volvo) .....	1	90-00	97002F	K54900
002I	A343F (Lexus, Landcruiser) .....	1	95-99	97002G	K54900C
002I	A343F (Lexus) .....	1	00-Up	97002J	K54900F
002I	A340H, A340F (AW4 Jeep) .....	1	87-99	97002F	K54900
002	A350 .....	1	96-98	97002G	K54900C
002	R150F Transfer Case .....	1	85-Up	197002	K54900T
<b>FILTER KITS</b>					
011I	A340E (2wd Some) .....	1	86-00	97011	FK54800
011I	A340F (4wd Some) (3/8" Neck) .....	1	95-97	97011D	FK54800F
011I	A340F, A343F (4wd Some) (3/4" Neck) .....	1	95-99	97011E	FK54800E
011I	A340E, A340F Jeep (AW4) (2wd & 4wd) .....	1	87-93	97011B	FK54800B
011I	A340H (4wd) .....	1	85-94	97011A	FK54800A
011I	A341E (2wd Some) .....	1	90-00	97011C	FK54800C
011I	A340E, A341E (2wd Some, 4wd Some) .....	1	94-Up	97011CA	FK54800G
011I	A340E, A340F, A343F (2wd Some, 4wd Some) (1" Neck) .....	1	98-Up	97011EA	FK54800L
<b>FILTERS (see photos pg 529)</b>					
010I	Pick-up (2wd) .....	1	89-94	97010	54800
010I	Pick-up (4wd) .....	1	85-94	97010A	54800A
010I	4 Runner (2wd) .....	1	89-99	97010	54800
010I	4 Runner (2wd) .....	1	00-01	97010CA	54800G
010I	4 Runner (2wd) .....	1	02-Up	97010EA	54800L

ILL.	DESCRIPTION	QTY.	YEAR	PART NO.	REFERENCE NO.
<b>FILTERS (Cont.)</b>					
010I	4 Runner (4wd).....	1	85-94	97010A	54800A
010I	4 Runner (4wd).....	1	95-99	97010E	54800E
010I	4 Runner (4wd).....	1	00-Up	97010EA	54800L
010I	Landcruiser.....	1	94-97	97010E	54800E
010I	Landcruiser.....	1	98-02	97010EA	54800L
010I	Sequoia .....	1	01-04	97010EA	54800L
010I	Tacoma (2wd).....	1	95-99	97010	54800
010I	Tacoma (2wd).....	1	00-01	97010CA	54800G
010I	Tacoma (2wd).....	1	02-Up	97010EA	54800L
010I	Tacoma (4wd).....	1	95-96	97010D	54800F
010I	Tacoma (4wd).....	1	97-99	97010E	54800E
010I	Tacoma (4wd).....	1	00-Up	97010EA	54800L
010I	Tundra (2wd) .....	1	99-00	97010	54800
010I	Tundra (2wd) .....	1	01-Up	97010CA	54800G
010I	Tundra (4wd) (V6).....	1	00-Up	97010CA	54800G
010I	Tundra (4wd) (V8).....	1	01-Up	97010EA	54800L
010I	T100 (2wd).....	1	93-98	97010	54800
010I	T100 (4wd).....	1	93-94	97010A	54800A
010I	T100 (4wd).....	1	95-97	97010D	54800F
010I	T100 (4wd).....	1	1998	97010E	54800E
<b>Other Applications:</b>					
010I	A340E (Also fits Cressida, Previa, Supra w/o Turbo, Lexus SC300).....	1	86-00	97010	54800
010I	A340F (3/8" Neck) .....	1	95-97	97010D	54800F
010I	A343F (1" Neck) .....	1	95-E96	97010H	54800H
010I	A340F, A343F (3/4" Neck) (Also fits Lexus LX450) .....	1	L96-Up	97010E	54800E
010I	A340E, A340F (All Jeeps) (AW4) (2wd & 4wd) .....	1	87-93	97010B	54800B
010I	A340H (4wd) (Also fits Isuzu Trooper 88-91) .....	1	85-94	97010A	54800A
010I	A341E (Also fits Lexus GS300, LS400, SC300, SC400..... Toyota Supra w/ Turbo, Volvo 960 & 90 Series) .....	1	90-00	97010C	54800C
010I	A340E, A341E (Also fits Lexus GS300) .....	1	94-Up	97010CA	54800G
010I	A340E, A340F, A343F (1" Neck) (Also fits Lexus LX470) .....	1	98-Up	97010EA	54800L
010I	A350E Lexus 3.0L.....	1	96-85	97010G	54800J
<b>BANDS</b>					
Prefix Key: B = Borg Warner, A = OEM (Exc. BW), N = All Other New, R = Relined					
022G	Brake .....	1	85-Up	97022	54700
<b>BUSHINGS</b>					
030I	Bushing Kit .....	1	85-Up	97030	K54901A
030I	Bushing Kit, R150F (Transfer Case).....	1	88-Up	197030A	K54901T
034A	Bushing, Front Pump.....	1	85-Up	57034A	46001
037A	Stator Support (Rear).....	1	85-Up	97037	54001
046G	Direct Drum .....	1	85-Up	97046	54005
047	Input Shaft.....	1	85-Up	97047	54006
050C	Front Planet Ring Gear.....	1	85-Up	97050	54007
066E	Extension Housing (35mm Yoke).....	1	85-Up	97066A	N/A
066E	Extension Housing (38mm Yoke).....	1	85-Up	57066A	46006
066E	Extension Housing (40mm Yoke).....	1	85-Up	97066	54010
<b>METAL CLAD SEALS</b>					
070A	Front Pump .....	1	85-Up	57070A	46200B
074E	Extension Housing (38 x 58 x 11mm) 2 1/4" OD 2wd.....	1	85-Up	57074A	42201A
074E	Extension Housing (40 x 58 x 11mm) 2 1/4" OD 2wd.....	1	85-Up	97074	54201
074E	Extension Housing 2 3/16" OD (Lexus, Volvo) .....	1	85-Up	97074C	54201C
074E	Adapter Housing (Transmission to Transfer Case-Jeep) .....	1	85-Up	97074B	54205A
074E	Transfer Case (Front & Rear) .....	1	85-Up	197074A	54205

TOYOTA A340

ILL.	DESCRIPTION	QTY.	YEAR	PART NO.	REFERENCE NO.
<b>FRICTION PLATES</b>					
100B	Overdrive Brake .083" (24 T).....	3-5	85-Up	97100	54100
102F	Overdrive Direct .083" (32 T).....	2	85-Up	97102	54101
104H	2nd Brake .078" (32 T).....	4-5	85-Up	97104	54104
106G	Direct .083" (40 T).....	3-4	85-Up	97106	54102
108C	Forward .067" (40 T).....	3-5	93-Up	97108	54103A
108C	Forward .075" (40 T).....	6-7	92-Up	97108B	54103B
108C	Forward .078" (40 T).....	6-7	92-Up	97108C	54103C
108C	Forward .083" (40 T).....	4-5	85-Up	97108A	54103
114D	Low & Reverse .067" (32 T).....	5-7	85-Up	97114	54105
N.I.	Transfer Case, Direct & Front .067" (44 T).....	5-6	88-95	197106A	54120
N.I.	Transfer Case, Low .067" (53 T).....	6-7	88-95	197114A	54121
<b>STEEL PLATES</b>					
120B	Overdrive Brake .078" (6 T).....	2-4	85-Up	97120	54106
120B	Overdrive Brake .078" (6 T) Volvo.....	3-4	92-Up	97120C	54106A
122F	Overdrive Direct .078" (24 T).....	1-2	85-Up	97122	54107
122F	Overdrive Direct .098" (24 T) Volvo.....	1	92-Up	97122C	54107B
122F	Overdrive Direct .118" (24 T).....	AR	85-Up	97122A	54107A
124H	2nd Brake .071" (16 T).....	1	85-Up	97124	54110
124H	2nd Brake .098" (16 T).....	4	85-Up	97124A	54110A
124H	2nd Brake .157" (16 T).....	AR	85-Up	97124B	54110B
126G	Direct .071" (6 T).....	3-4	93-99	87122AD	54108C
126G	Direct .091" (24 T).....	4	00-Up	97126D	54108E
126G	Direct .091" (6 T).....	1-4	85-99	97126	54108A
126G	Direct .118" (6 T).....	4	87-99	97126A	54108
126G	Direct .157" (6 T).....	4	87-99	97126B	54108B
128C	Forward .071" (8 T).....	6-7	92-Up	67122A	75101
128C	Forward .078" (8 T).....	4-5	85-91	97128	54109
128C	Forward .091" (8 T).....	4-5	92-Up	97128C	54109A
134D	Low & Reverse .071" (15 T).....	5-7	85-Up	97134	54111
N.I.	Transfer Case, Direct & Front .071" (29 T).....	5-6	88-95	197126A	54122
N.I.	Transfer Case, Direct & Front .100" (29 T).....	1	88-95	197126AA	54122A
N.I.	Transfer Case, Low .071" (8 T).....	4-6	88-95	197134A	54123
<b>PRESSURE PLATES</b>					
<b>Prefix Key: D = OEM, A = Aftermarket New, R = Remanufactured</b>					
148C	Forward.....	1	85-Up	97148	N/A
<b>SEALING RINGS</b>					
175I	Ring Kit.....	1	85-Up	97175	K54300
<b>THRUST WASHERS</b>					
200I	Washer Kit.....	1	85-Up	97200A	N/A
<b>BEARINGS &amp; RACES</b>					
240	Race, Sun Gear Shaft to Bearing (Front).....	1	85-04	97240	N/A
241D	Bearing, Sun Gear Shaft.....	1	85-Up	97241	N/A
242D	Race, Sun Gear Shaft to Bearing (Rear).....	1	85-Up	97242	N/A
<b>GASKETS &amp; O-RINGS</b>					
300I	Gasket, Bottom Pan (Cork) (incl A350).....	1	85-Up	97300	13810X
300I	Gasket, Bottom Pan (Fiber) (incl A350).....	1	85-Up	97300F	13810F
304	Gasket, Transfer Case (Cork).....	1	85-Up	197304	13820X
304	Gasket, Transfer Case (Fiber).....	1	85-Up	197304F	13820F











ILL.	DESCRIPTION	QTY.	YEAR	PART NO.	REFERENCE NO.
<b>GASKETS &amp; O-RINGS (Cont.)</b>					
305	Gasket, Extension Housing (2wd).....	1	85-Up	57305A	13402
311A	O-Ring, Pump to Case.....	1	85-Up	97311	13542
326I	Gasket, Filter (1 Piece).....	1	85-Up	97326	N/A
326I	Gasket, Filter (2 Piece).....	1	85-Up	97326A	13899
320	Gasket Package, Valve Body (95-Up) (Jeep).....	1	95-Up	97320BK	K13697B
320	Gasket Package, Valve Body (89-99) (Exc. A341E).....	1	89-99	97320BK	K13697B
320	Gasket Package, Valve Body (90-00) (Exc. A341E).....	1	90-00	97320CK	K13697C
<b>TECHNICAL MANUALS</b>					
400I	Tech Manual (AW30-80LE) (Isuzu).....	1	85-Up	97400	54Y04
400I	Tech Manual (Toyota, Jeep AW-4).....	1	85-Up	97400A	54Y02
400I	Tech Manual (R150F Transfer Case).....	1	85-Up	197400	N/A
<b>ELECTRICAL COMPONENTS</b>					
420	Solenoid Kit (Shift Only) A340E.....	1	85-Up	67420CK	31R-401
420	Solenoid Kit (Shift Only) A341E.....	1	85-Up	97420AK	31R-401S
420	Solenoid Kit, A340E (3 Solenoids w/ Cable).....	1	85-97	97420K	31R-401D
420	Solenoid Kit, A340E (4 Solenoids w/o Cable).....	1	98-Up	97420BK	N/A
420	Solenoid Kit, A341E (4 Solenoids w/ Cable).....	1	90-97	97420DK	N/A
420	Solenoid Kit, A341E (4 Solenoids w/o Cable).....	1	93-98	97420BK	N/A
420	Solenoid Kit, A341E (5 Solenoids w/o Cable).....	1	93-Up	97420CK	N/A
421	Solenoid, Shift.....	2	85-94	67421D	N/A
425	Solenoid, Lock-Up (Toyota).....	1	85-94	97425	N/A
425	Solenoid, Lock-Up (Toyota).....	1	95-01	97425A	N/A
425	Solenoid, Lock-Up (Lexus SC300).....	1	92-97	97425	N/A
445	Repair Kit, External Wire Harness (6 Plug-in, Fits 6 Prong Connector).....	1	85-Up	97445EAK	N/A
445	Repair Kit, External Wire Harness (6 Prong).....	1	85-Up	97445EK	N/A
<b>HARD PARTS</b>					
<b>Prefix Key: D = OEM, A = Aftermarket New, R = Remanufactured</b>					
<b>PUMPS</b>					
500A	Pump, Complete (Exc. Lexus).....	1	85-Up	97500	54920
500A	Pump, Complete (Lexus).....	1	90-Up	97500BA	54920B
<b>DRUMS &amp; CLUTCH HUBS</b>					
551A	Overdrive w/ 31 Tooth Sun Gear.....	1	85-Up	97551B	54922A
551A	Overdrive w/ 33 Tooth Sun Gear.....	1	85-Up	97551	54922D
554G	Forward w/ Shaft (5 Clutch) (4wd).....	1	85-Up	97554A	54925
554G	Forward w/ Shaft (6 Clutch).....	1	85-Up	97554B	54925B
555G	Direct (5 Clutch) 4 5/8" OD Piston.....	1	85-Up	97555EA	54923
555G	Direct (5 Clutch) 5" OD Piston.....	1	85-Up	97555E	54923B
555G	Direct (R150F Transfer Case).....	1	85-Up	197555	N/A
<b>PLANETS</b>					
580F	Overdrive w/ Shaft (33 T Sun Gear).....	1	85-Up	97580A	54921
580F	Overdrive w/ Shaft (31 T Sun Gear).....	1	85-Up	97580B	54921A
582C	Front.....	1	85-Up	97582A	N/A
584D	Rear (23 T Pinion).....	1	85-Up	97584A	N/A
584D	Rear (19 T Pinion).....	1	85-Up	97584AA	N/A
583	Planet Set (A340).....	1	85-Up	97583	K54950
583	Planet Set (A341).....	1	85-Up	97583B	K54950B
592C	Ring Gear, w/ Hub Front Planet.....	1	85-Up	97592A	N/A
594D	Ring Gear, Rear Planet.....	1	85-Up	97594A	N/A

TOYOTA A340





# TOYOTA A340-A350 FILTERS

 <p>97010</p>	 <p>97010G (350)</p>
 <p>97010C</p>	 <p>97010CA</p>
 <p>97010A</p>	 <p>97010B</p>
 <p>97010E</p> <p>3/4" Neck</p>	 <p>97010EA</p> <p>1" Neck</p>
 <p>97010D</p> <p>3/8" Neck</p>	 <p>97010H</p> <p>1" Neck</p>

A340-A350 FILTERS

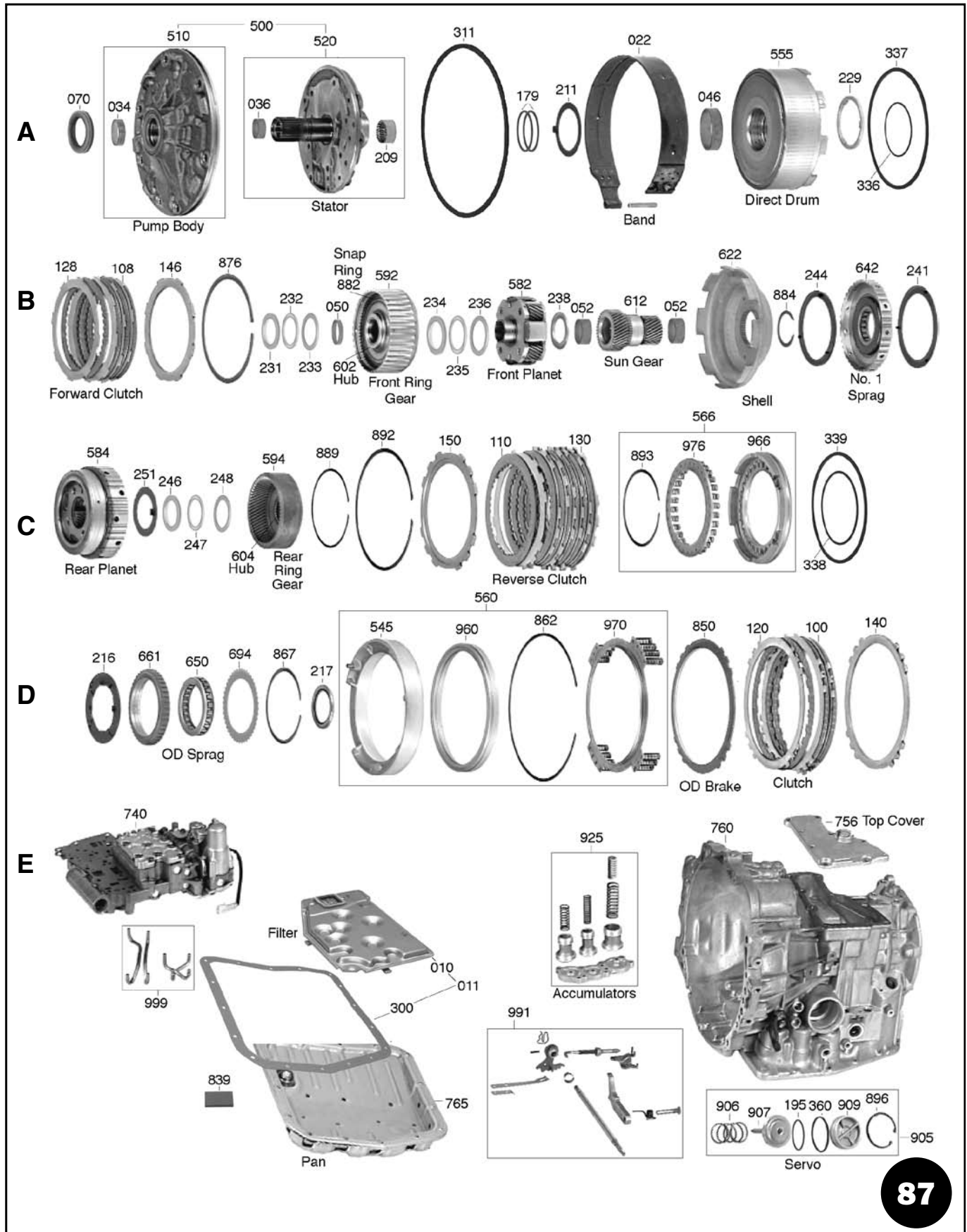

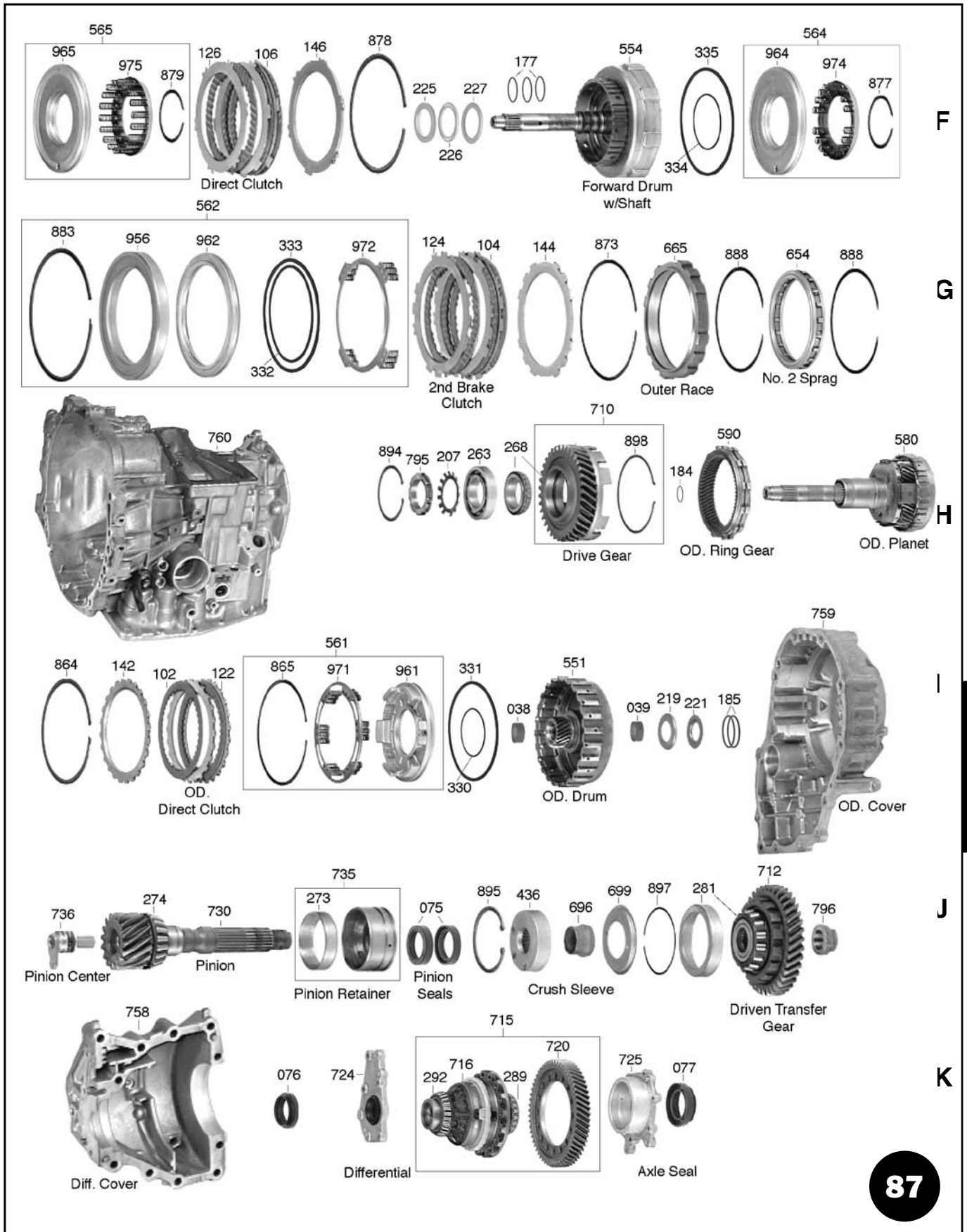

A540

F

G

H

I

J

K

ILL.	DESCRIPTION	QTY.	YEAR	PART NO.	REFERENCE NO.
<b>MASTER OVERHAUL KITS (WITH STEELS)</b>					
006J	A540E (88-5/91) .....	1	88-E91	87006AF	K7500F
006J	A540E (6/91-93) (Incl 98-00 Sienna) .....	1	L91-93	87006AAF	K7500J
006J	A540H (RAV-4 4wd) (Differential, also order 87001).....	1	96-Up	87006ABF	K7500R
006J	A541E (Exc. 98-00 Sienna) .....	1	94-Up	87006BF	K7500H
<b>LESS STEEL KITS</b>					
004J	A540E (88-5/91) .....	1	88-E91	87004AF	K7500F-LS
004J	A540E (6/91-93) (Incl 98-00 Sienna) .....	1	L91-93	87004AAF	K7500J-LS
004J	A540H (RAV-4 4wd) (Differential, also order 87001).....	1	96-Up	87004ABF	K7500R-LS
004J	A541E (Exc. 98-00 Sienna) .....	1	94-Up	87004BF	K7500H-LS
001J	Sub Kit, A540H Differential Only .....	1	88-93	87001	K75900-5H
<b>OVERHAUL KITS (W/ RINGS &amp; SEALS)</b>					
002J	A540E (Incl 98-00 Sienna) .....	1	88-93	87002AF	K75900F
002J	A540H (RAV-4 4wd) (Differential, also order 87001).....	1	88-93	87002AF	K75900F
002J	A541E (Exc. 98-00 Sienna) .....	1	94-Up	87002BF	K75900H
001J	Sub Kit, A540H Differential Only .....	1	88-93	87001	K75900-5H
<b>FILTER KITS</b>					
011E	A540E, A540H.....	1	88-Up	87011	FK75800B
011E	A541E .....	1	94-Up	87011A	FK75800D
<b>FILTERS</b>					
010E	A540E, A540H.....	1	88-Up	87010	75800B
010E	A541E .....	1	94-Up	87010A	75800D
<b>BANDS</b>					
<b>Prefix Key: B = Borg Warner, A = OEM (Exc. BW), N = All Other New, R = Relined</b>					
022A	Band, 1.00" Wide.....	1	89-Up	67022B	75700
022A	Band, 1.22" Wide .....	1	94-Up	87022C	75700B
022A	Band, 1.50" Wide.....	1	88-93	87022B	75700A
<b>BUSHINGS</b>					
030J	Bushing Kit .....	1	88-Up	87030	K75901C
034A	Pump Body .....	1	88-Up	57034A	46001
036A	Stator Support (Front) .....	1	88-Up	57036C	46007A
037	Stator Support (Rear) (Bushing) .....	1	88-Up	67037A	75003
038I	Overdrive Sun Gear (Front) .....	1	88-Up	67038C	75008
038I	Overdrive Sun Gear (Rear).....	1	88-Up	67038CA	75007
046A	Direct Drum .....	1	88-Up	87046A	75005A
050B	Input Hub.....	1	88-Up	87050A	75006A
052B	Sun Gear.....	2	88-Up	87052A	75004A
<b>METAL CLAD SEALS</b>					
070A	Front Pump .....	1	88-Up	57070A	46200B
072	Manual Lever Shaft .....	2	88-Up	60072	50203
075J	Transfer Shaft Seal.....	2	88-93	87075A	75203A
074	Extension Housing (A540H Awd).....	1	88-91	87074A	46201G
076J	Right Axle (A540E, A541E) .....	1	88-Up	87076A	75201D
076J	Right Axle (A540H) (Awd) .....	1	88-Up	87076B	75201G
077J	Left Axle (A540E, A541E).....	1	88-Up	87077A	75201E
077J	Left Axle (A540H) (Awd) .....	1	88-Up	67077D	75201F
078	Speedometer Gear Shaft .....	1	88-Up	57078A	46203

ILL.	DESCRIPTION	QTY.	YEAR	PART NO.	REFERENCE NO.
<b>FRICITION PLATES</b>					
100D	Overdrive Brake (Grooved) .....	3	88-91	87100A	75102D
100D	Overdrive Brake (Smooth) .....	3	92-Up	87100AA	75102F
102I	Overdrive Direct .....	2	88-Up	67106C	75100C
104G	2nd Brake (33 T) (Also A541E 94-Up).....	3	88-91	67100CA	75102A
104G	2nd Brake (33 T).....	3	92-Up	87100CB	75102E
104G	2nd Brake (36 T).....	3-4	94-Up	87100CC	75102G
106F	Direct (.067") (40 T) .....	3-4	89-Up	67106A	75100B
106F	Direct (.081") (32 T) (Grooved).....	3	88-Up	87106AB	75100A
106F	Direct (.083") (40 T) (Smooth) .....	3	94-Up	97106	54102
108B	Forward (.060") .....	5	94-Up	87106A	75100D
108B	Forward (.067") .....	4	88-Up	67106A	75100
110C	Reverse (33 T) .....	6-7	88-Up	67100B	75102C
110C	Reverse (36 T) .....	6-7	94-Up	87100B	75102H
118	Differential .....	11	89-Up	87103A	75120
<b>STEEL PLATES</b>					
120D	Overdrive Brake (.071").....	3	88-Up	67120CA	75105A
120D	Overdrive Brake (.098").....	3	88-Up	67120CB	N/A
122I	Overdrive Direct (.071") .....	2	94-Up	67122C	75101A
122I	Overdrive Direct (.078") .....	2	94-Up	87122CB	N/A
122I	Overdrive Direct (.119") .....	2	89-Up	97122A	54107A
124G	2nd Brake (10 T).....	3	94-Up	87124B	75103A
124G	2nd Brake (12 Long T) .....	3	88-Up	87124A	75103
124G	2nd Brake (12 Short T) .....	3	88-Up	67120B	75105B
126F	Direct (.055") (6 T) .....	1	94-Up	87122BA	75101H
126F	Direct (.071") (6 Notched T) .....	1	88-Up	87122AD	54108C
126F	Direct (.071") (8 T) .....	3	89-Up	67122A	75101
126F	Direct (.078") (6 T, 3 T are Notched) .....	2-3	94-Up	87122BB	75101G
126F	Direct (.091") (6 T) .....	2	88-Up	97126	54108A
128B	Forward (.055") .....	1	92-Up	87122AA	75101F
128B	Forward (.063") .....	4	92-Up	87122A	75101E
128B	Forward (.071") .....	4	88-Up	67122A	75101
128B	Forward (.078") .....	5	94-Up	97128	54109
130C	Reverse (.063") (10 T).....	6	94-Up	87130AA	75105D
130C	Reverse (.071") (12 T).....	6-7	88-Up	67130D	75105C
138	Differential .....	11	88-Up	87123A	75121
<b>PRESSURE PLATES</b>					
<b>Prefix Key: D = OEM, A = Aftermarket New, R = Remanufactured</b>					
146B	Forward (2.6mm).....	1	88-Up	67146B	75515
146B	Forward (2.8mm).....	1	88-Up	67146BA	75515A
146B	Forward (3.0mm).....	1	88-Up	67146AA	75515B
146B	Forward (3.2mm).....	1	88-Up	67146AB	75515C
146B	Forward (3.4mm).....	1	88-Up	67146A	75515D
<b>VALVE BODY RECALIBRATION KITS</b>					
165J	Kit, A540E/A540H Valve Body Upgrade (TransLab).....	1	88-Up	87165A	75D01
<b>THRUST WASHERS</b>					
200J	Washer Kit .....	1	88-93	87200A	K75400C
200J	Washer Kit (Incl 67211AA, 87241, 87251A, 87251B, 87251C) .....	1	94-Up	87200B	K75400D
211A	Stator to Direct Drum .....	1	88-Up	67211AA	75404
216D	Overdrive Planet to Sprag (Plastic).....	1	88-Up	87216	75932A
217	Overdrive Planet, Bronze (.060").....	1	83-Up	67217A	75932
217	Overdrive Planet, Bronze (.110").....	1	83-Up	62717C	75932B
229A	Direct Drum to Forward Drum (.138" Thick) .....	1	88-Up	67229A	75405

A540

ILL.	DESCRIPTION	QTY.	YEAR	PART NO.	REFERENCE NO.
<b>THRUST WASHERS (Cont.)</b>					
229A	Direct Drum to Forward Drum (.175" Thick) .....	1	88-Up	87229	75405A
244B	Shell to Sprag (A540).....	1	88-Up	87244	75402A
244B	Shell to Sprag (A541).....	1	94-Up	87244A	75402B
241B	Rear Planet #2 Front (Plastic) (A540) .....	1	88-93	87241	75401A
251C	Rear Planet #2 Front (Plastic) (A541) .....	1	94-Up	87251C	75401B
241B	Rear Planet #2 Rear (Plastic) (A540).....	1	88-93	67241A	75401
251C	Rear Planet #2 Rear (Plastic) (A541).....	1	94-Up	87251B	75401D
<b>BEARINGS &amp; RACES</b>					
219I	Bearing w/ Race, Overdrive Drum to Cover .....	1	88-Up	67219CA	N/A
221I	Race, Overdrive Drum to Case Cover (Rear) .....	1	88-Up	67221C	75936
226F	Bearing, Stator to Forward Drum .....	1	88-Up	67226A	N/A
232B	Bearing, Forward Drum to Hub .....	1	88-Up	67232A	N/A
274J	Bearing, Differential Pinion Cone w/ Race (Front) (18 Roller) .....	1	88-01	87274B	N/A
289J	Tapered Bearing, Differential (Ring Gear Side).....	1	1989	87289	N/A
292J	Tapered Bearing, Differential (Speed-O-Gear Side) .....	1	1989	87292	N/A
<b>GASKETS &amp; O-RINGS</b>					
300E	Gasket, Bottom Pan (A540) (Cork) .....	1	88-00	87300	13470BX
300E	Gasket, Bottom Pan (A540) (Fiber).....	1	88-00	87300F	13470BF
300E	Gasket, Bottom Pan (A541E) (Cork) .....	1	94-03	87300E	13470DX
300E	Gasket, Bottom Pan (A541E) (Fiber).....	1	94-03	87300EF	13470DF
311	O-Ring, Pump .....	1	88-Up	67311B	13471
326E	Gasket, Filter (A540) .....	1	88-Up	87326	13474B
326E	Gasket, Filter (A541) .....	1	88-Up	87326A	13474D
<b>TECHNICAL MANUALS</b>					
400J	Tech Manual .....	1	88-Up	87400	75Y06
<b>ELECTRICAL COMPONENTS</b>					
420	Solenoid Kit (# 1 & # 2 Shift Solenoids & 1 Bracket) (A540E, A540H) .....	1	88-93	87420BK	31R-402
420	Solenoid Kit (2 Shift & 1 Lock-Up Solenoid) (A540E, A540H) .....	1	88-93	87420K	31R-402C
420	Solenoid Kit (# 1 & # 2 Shift Solenoids & 1 Bracket) (A541E).....	1	94-Up	87420AK	31R-402S
420	Solenoid Kit (# 1 & # 2 Shift, 1 L-Up Solenoid & 1 Bracket) (A541E).....	1	94-Up	87420CK	31R-402E
425	Solenoid, Lock-Up (A540E, A540H) .....	1	88-93	87425	5R-407
425	Solenoid, Lock-Up (A541E).....	1	94-Up	87425A	5R-408
436J	Speed Sensor (VSS) (# 2 Speed Sensor) (Mounts on Pinion Shaft).....	1	88-Up	87436	N/A
436J	Speed Sensor (VSS) (Speedo) (Camry).....	1	97-Up	87436A	20R-540
445	Repair Kit, External Wire Harness (5 Plug-in, Fits 5 Prong Connector) .....	1	88-Up	87445EAK	N/A
445	Repair Kit, External Wire Harness (5 Prong) .....	1	88-Up	87445EK	N/A
<b>HARD PARTS</b>					
<b>Prefix Key: D = OEM, A = Aftermarket New, R = Remanufactured</b>					
<b>PUMPS</b>					
500A	Pump Complete (A540).....	1	88-Up	87500A	75920E
500A	Pump Complete (A541).....	1	88-Up	87500B	75920C
<b>DRUMS &amp; CLUTCH HUBS</b>					
551I	Overdrive Direct (22 T Sun Gear) .....	1	88-Up	87551A	75935D
551I	Overdrive Direct (27 T Sun Gear) .....	1	88-Up	87551E	75935E
554F	Forward w/ Shaft (3 Ring, 4 Clutch) .....	1	88-Up	87554	75922C
554F	Forward w/ Shaft (3 Ring, 5 Clutch) .....	1	88-Up	87554A	75922E
551I	Overdrive Direct (28 T Sun Gear) .....	1	88-Up	87551D	75935F
554F	Forward w/ Shaft (2 Ring, 4 Clutch) .....	1	88-Up	67554C	75922A

ILL.	DESCRIPTION	QTY.	YEAR	PART NO.	REFERENCE NO.
<b>DRUMS &amp; CLUTCH HUBS (Cont.)</b>					
555A	Direct (8 Drive Lugs at Shell) (1.00" Wide Band) .....	1	88-Up	67555CA	75921D
555A	Direct (8 Drive Lugs at Shell) (1.22" Wide Band) .....	1	88-Up	87555	75921C
555A	Direct (16 Drive Lugs at Shell) .....	1	88-Up	87555B	75921E
<b>PLANETS</b>					
580H	Planet, Overdrive w/ Shaft (22 T Sun Gear # 551) .....	1	88-Up	87580A	75927D
580H	Planet, Overdrive w/ Shaft (27 T Sun Gear # 551) .....	1	88-Up	87580B	N/A
580H	Planet, Overdrive w/ Shaft (28 T Sun Gear # 551) .....	1	88-Up	87580D	75927F
582B	Planet, Front (No Hub on Front) .....	1	88-Up	67582A	75925
582B	Planet, Front (Has Hub on Front) .....	1	88-Up	87582	N/A
584C	Planet, Rear (4 Gear) (1.790" Overall Height) .....	1	88-Up	67584A	N/A
584C	Planet, Rear (4 Gear) (1.885" Overall Height) .....	1	88-Up	87584	N/A
584C	Planet, Rear (5 Gear) .....	1	88-Up	87584A	N/A
584C	Planet Set, Complete (4 Gear Rear Planet) .....	1	88-Up	67583GK	K75925C
584C	Planet Set, Complete (5 Gear Rear Planet) .....	1	88-Up	87583	K75925D
594C	Ring Gear, Rear (1.100" Thick) .....	1	88-Up	67594	N/A
594C	Ring Gear & Hub, Rear (1.100" Thick) .....	1	88-Up	67594K	N/A
594C	Ring Gear, Rear (1.165" Thick) .....	1	88-Up	87594	N/A
<b>SUN GEARS, SHELLS &amp; SUPPORTS</b>					
612B	Sun Gear, Front (27 Teeth, 1.465" OD Sprag Race) .....	1	88-Up	67612B	N/A
612B	Sun Gear, Front (27 Teeth, 1.540" OD Sprag Race) .....	1	88-Up	87612	N/A
622B	Shell, Input Sun (39 Inner T) (8 Drive Lugs) .....	1	88-Up	67622A	N/A
<b>SPRAGS</b>					
642B	Sprag, Intermediate (A540, A541) .....	1	88-Up	87642	75502
642B	Sprag w/ Outer Race, Intermediate (33 T) (A540) .....	1	88-Up	87642A	K75502
642B	Sprag w/ Outer Race, Intermediate (36 T) (A541) .....	1	88-Up	87642B	K75502B
650D	Sprag, Overdrive .....	1	88-Up	67650C	75929
654G	Sprag, Low Clutch (20 Elements) .....	1	88-Up	67654A	75926
654G	Sprag, Low Clutch (30 Elements) .....	1	88-Up	87654	75926B
654G	Sprag, Low Clutch (32 Elements) .....	1	88-Up	87654A	75926C
654G	Sprag, Low Clutch w/ Race (20 Elements) .....	1	88-Up	87644	K75926A
654G	Sprag, Low Clutch w/ Race (30 Elements) .....	1	88-Up	87644A	K75926B
654G	Sprag, Low Clutch w/ Race (32 Elements) .....	1	88-Up	87644B	K75926C
<b>VALVE BODIES</b>					
740E	Valve Body (Premium) (A540E) (3 Solenoid w/ Tube) .....	1	88-Up	87740-1	P75990
740E	Valve Body (Premium) (A540E) (3 Solenoid w/o Tube) .....	1	88-Up	87740-2	P75990B
740E	Valve Body (Premium) (A540H) (4 Solenoid Awd) .....	1	88-Up	87740-3	P75990H
740E	Valve Body (Premium) (A541E) (4 Solenoid w/ Tube) .....	1	88-Up	87740-4	P75990K
741E	Pressure Regulator Valve Kit (req T-89010-TL) .....	1	83-Up	67741P	K75882
741E	Pressure Boost Valve & Sleeve (.565" Large Spool) .....	1	88-Up	S87741FA	K75976C
741E	Pressure Boost Valve & Sleeve (.583" Large Spool) .....	1	88-Up	S87741F	K75976B
<b>MISCELLANEOUS COMPONENTS</b>					
736J	Pinion Center (Aluminum 1 Bolt) (1.020" OD) .....	1	88-Up	67736B	N/A
759I	Rear Cover, Overdrive 13 Bolts w/ 4 Mounting Holes .....	1	88-Up	87759B	75941D
759I	Rear Cover, Overdrive 14 Bolts w/ 4 Mounting Holes .....	1	88-Up	87759CA	75941F
696J	Crush Sleeve (.940" Long) .....	1	88-Up	87696	75943B
696J	Crush Sleeve (1.565" Long) .....	1	88-Up	87696A	75943C
796	Nut, Pinion Shaft .....	1	88-Up	87796	75944B



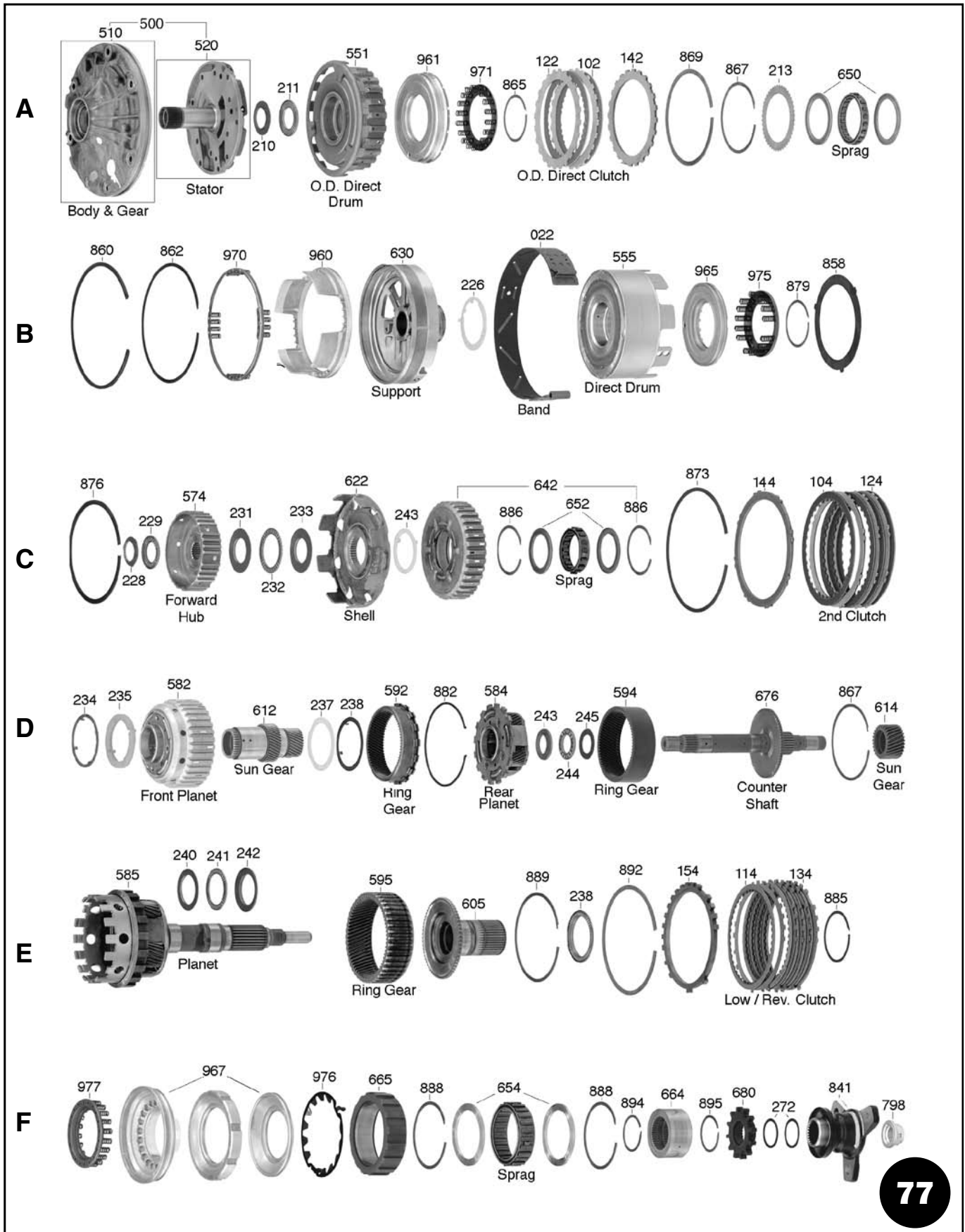

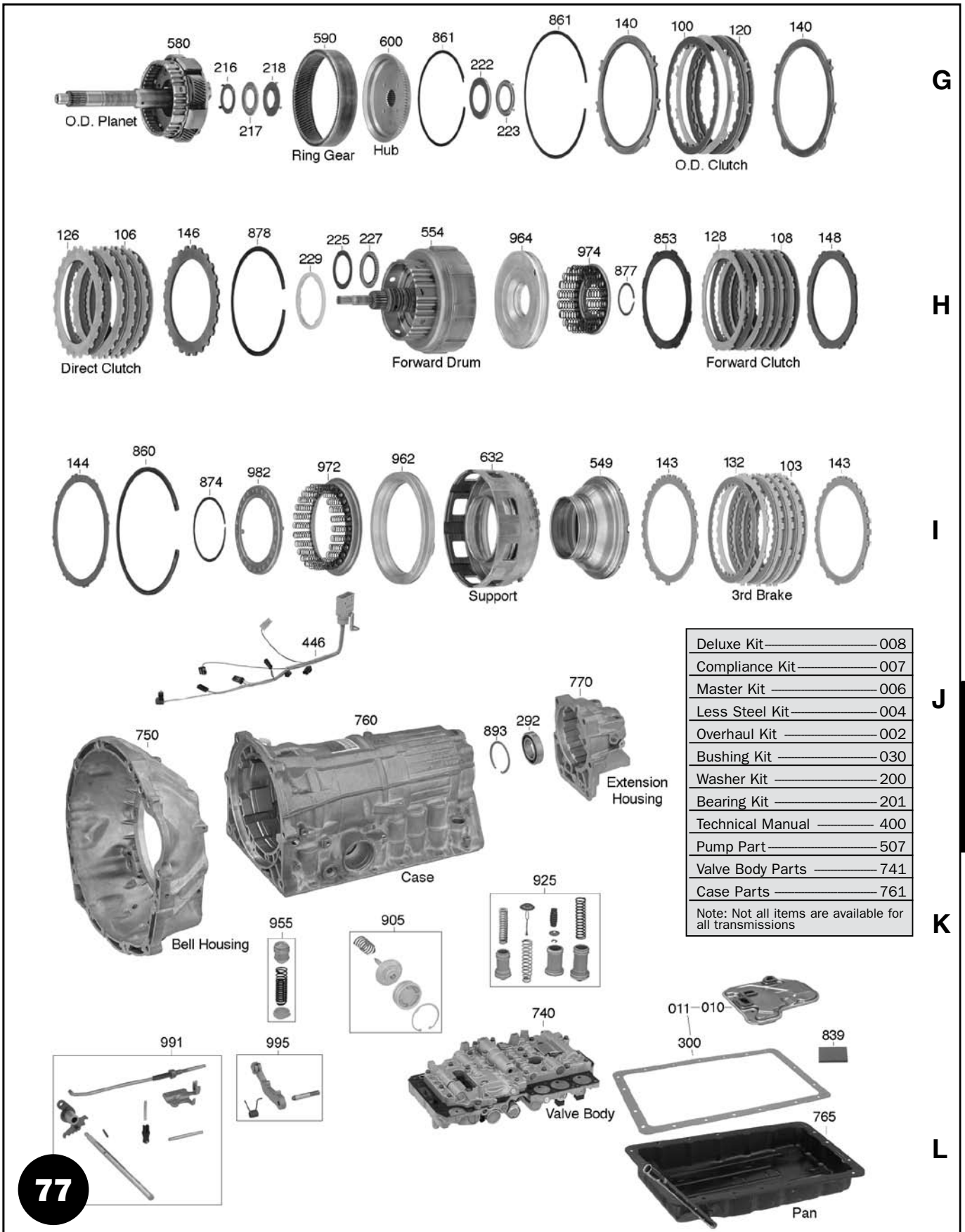

ILL.	DESCRIPTION	QTY.	YEAR	PART NO.	REFERENCE NO.
<b>MASTER OVERHAUL KITS (WITH STEELS)</b>					
006	A650E (Exc. GS300) .....	1	98-Up	77006	K5400D
006	A650E (GS300) .....	1	98-Up	77006A	N/A
<b>LESS STEEL KITS</b>					
004	A650E (Exc. GS300) .....	1	98-Up	77004	K5400D-LS
004	A650E (GS300) .....	1	98-Up	77004A	N/A
<b>OVERHAUL KITS (W/ RINGS &amp; SEALS)</b>					
002	A650E .....	1	98-Up	77002	K54900D
<b>FILTER KITS</b>					
011	Filter Kit .....	1	98-Up	77011B	FK54800K
<b>FILTERS</b>					
010	Filter .....	1	98-Up	77010B	54800K
<b>BANDS</b>					
<b>Prefix Key: B = Borg Warner, A = OEM (Exc. BW), N = All Other New, R = Relined</b>					
022	Brake Band .....	1	98-Up	97022	54700
<b>METAL CLAD SEALS</b>					
070	Seal, Pump .....	1	98-Up	57070A	46200B
<b>FRICTION PLATES</b>					
100	Overdrive Brake .....	3-4	98-Up	97100	54100
102	Overdrive Direct .....	2	98-Up	97102	54101
103	3rd Brake .....	5	98-Up	77103	54112
104	2nd Brake .....	5	98-Up	77104	54104D
106	Direct .....	5	98-Up	77106	54102D
108	Forward .....	5-6	98-Up	97108B	54103B
114	Low Reverse .....	5-6	98-Up	77114	54105B
<b>STEEL PLATES</b>					
120	Overdrive Brake .....	2-3	98-Up	97120C	54106A
122	Overdrive Direct (.079") .....	1-2	98-Up	97122	54107
122	Overdrive Direct (.098") .....	1	98-Up	97122C	54107B
123	3rd Brake .....	5	98-Up	77123	54113
124	2nd Brake (.106") .....	4	98-Up	77124	54110D
124	2nd Brake (.079") .....	1	98-Up	77124A	54110E
126	Direct .....	5	98-Up	77126	54108D
128	Forward (.071") .....	5	98-Up	67122A	75101
128	Forward (.055") .....	1	98-Up	87122AA	75101F
128	Forward (.091") .....	5	98-Up	97128C	54109A
134	Low Reverse .....	4-5	98-Up	77134	54111B
<b>MISCELLANEOUS COMPONENTS</b>					
300	Gasket, Pan (Cork) .....	1	98-Up	97300	13810X
300	Gasket, Pan (Fiber) .....	1	98-Up	97300F	13810F
320	Gasket Package, Valve Body .....	1	98-Up	77320K	K13967E
431	Solenoid, EPC .....	1	98-01	77431	N/A
425	Solenoid, Lock-Up (TCC) .....	1	98-01	77425	N/A
428	Solenoid, Shift Control .....	1	98-01	77428	N/A



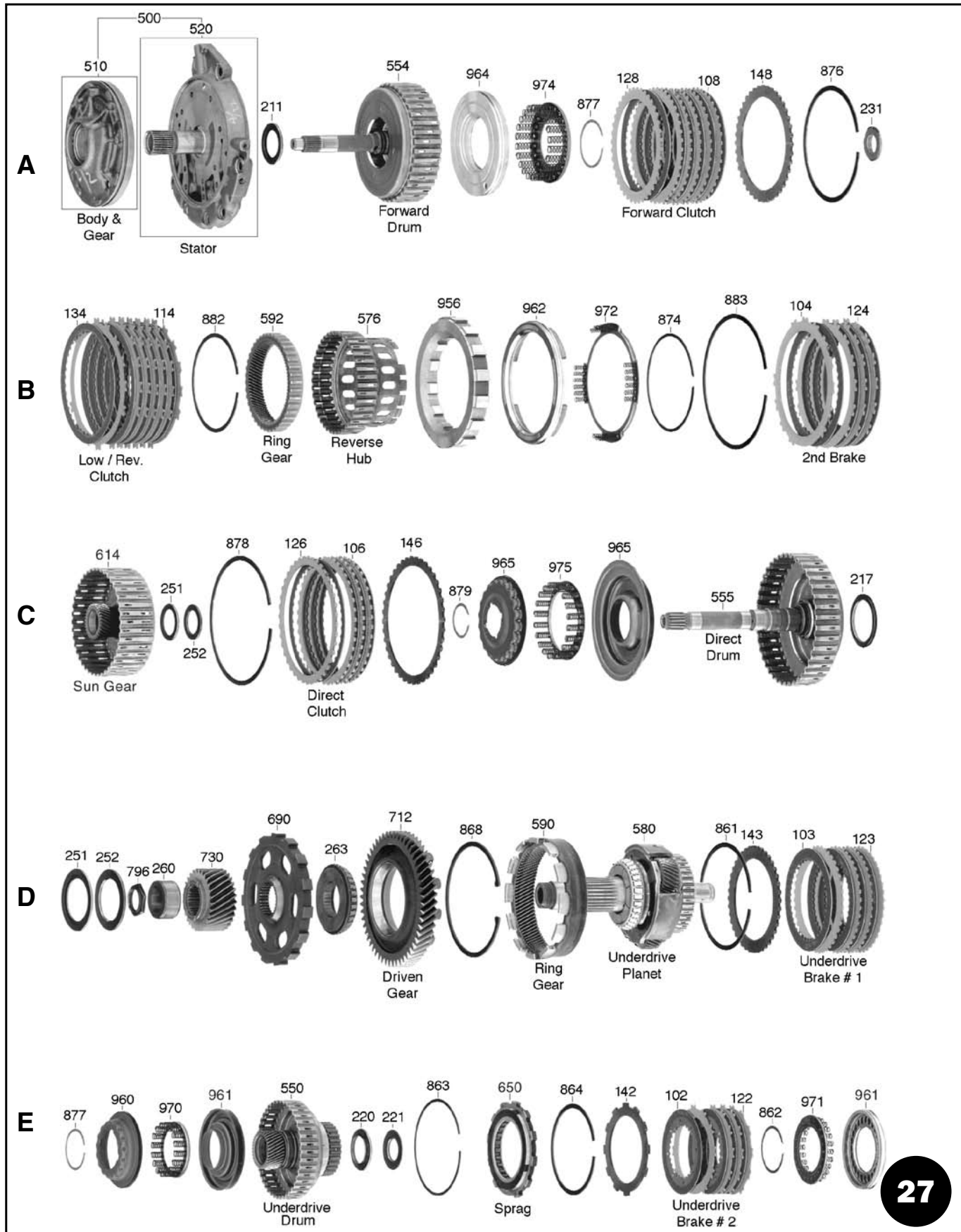

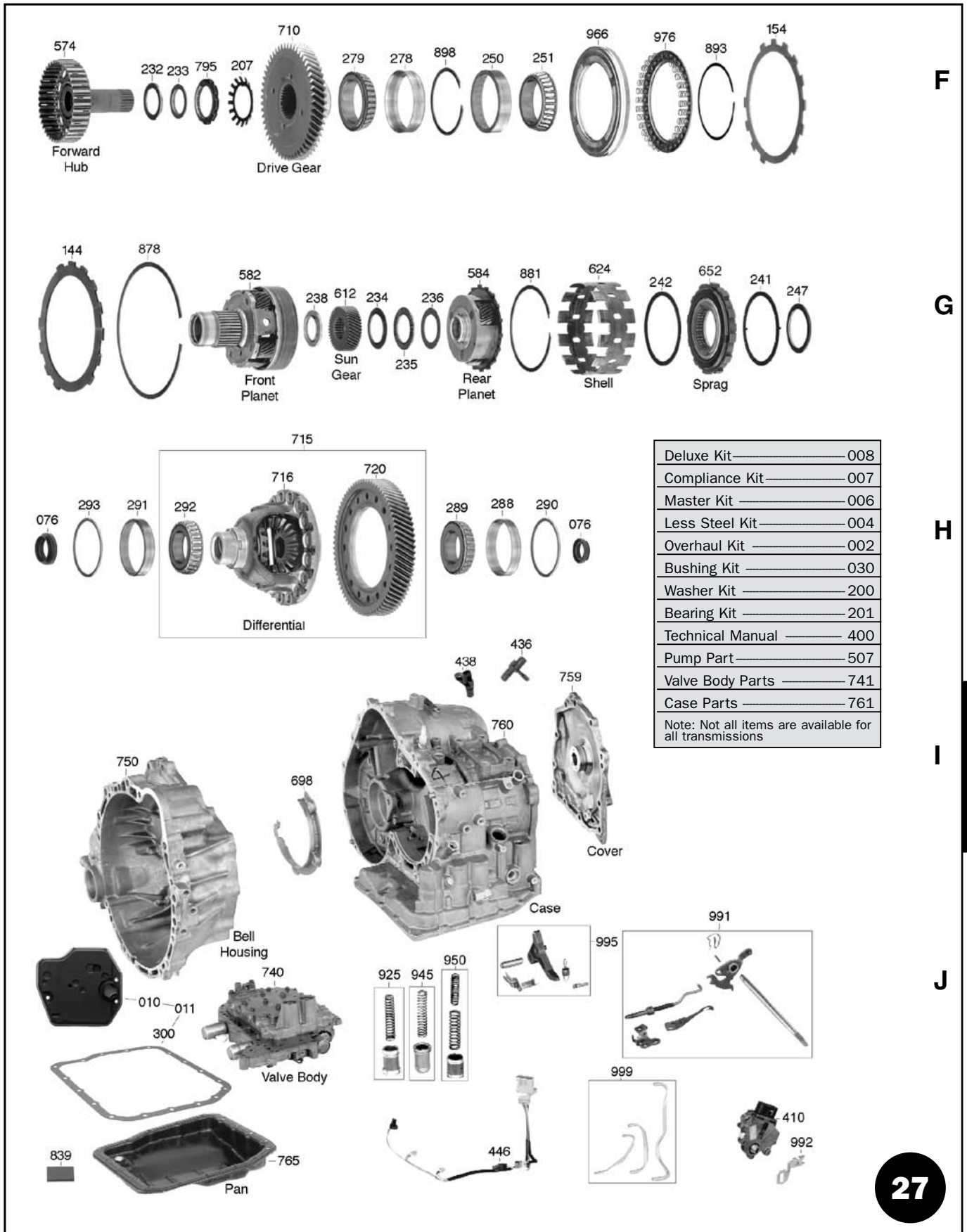

Deluxe Kit	008
Compliance Kit	007
Master Kit	006
Less Steel Kit	004
Overhaul Kit	002
Bushing Kit	030
Washer Kit	200
Bearing Kit	201
Technical Manual	400
Pump Part	507
Valve Body Parts	741
Case Parts	761
Note: Not all items are available for all transmissions	

F

G

H

I

J

U140, U240E

# TOYOTA

## U140, U240, U241

### FWD - 4 SPEED



**27010**  
U140/240



**27010A**  
U140/240

<b>U140E/F - 4 Spd</b>	
Lexus ES300, RX300	99-Up
RAV4	00-Up
Highlander	02-Up
<b>U240E - 4 Spd</b>	
Celica GTS	00-Up

ILL.	DESCRIPTION	QTY.	YEAR	PART NO.	REFERENCE NO.
<b>MASTER OVERHAUL KITS (WITH STEELS)</b>					
006	U140E, U140F (w/ Bonded Pistons) .....	1	98-Up	27006	K8900
006	U240E, U241E (w/ Bonded Pistons) .....	1	00-Up	27006A	K8900B
<b>LESS STEEL KITS</b>					
004	U140E, U140F (w/ Bonded Pistons) .....	1	98-Up	27004	K8900-LS
004	U240E, U241E (w/ Bonded Pistons) .....	1	00-Up	27004A	K8900B-LS
<b>OVERHAUL KITS (W/ RINGS &amp; SEALS)</b>					
002	U140E, U140F (w/ Bonded Pistons) .....	1	98-Up	27002	K89900
002	U240E, U241E (w/ Bonded Pistons) .....	1	00-Up	27002A	K89900B
002	U140E, U140F, 240E, U241E (Combo) (w/o Bonded Pistons) .....	1	00-Up	27002C	N/A
<b>SUB KITS</b>					
001	U140F Transfer Case .....	1	98-Up	27001	K89900T
<b>FILTER KITS</b>					
011	Metal & Plastic (Replaces All Metal) .....	1	98-Up	27011A	FK89800
<b>FILTERS</b>					
010	All Metal (Lexus RX300 1/98 to 4/98) .....	1	98-98	27010	89800A
010	Metal & Plastic (Replaces All 99-Up) .....	1	99-Up	27010A	89800
<b>BUSHINGS</b>					
030	Bushing Kit .....	1	99-Up	27030	K89901
034	Pump .....	1	99-Up	57034A	46001
<b>METAL CLAD SEALS</b>					
070	Front Pump .....	1	98-Up	57070A	46200B
076	Axle (Right side) (U140E) (2wd) .....	1	98-Up	87076A	75201D
070	Axle (Right side) (U140F) (4wd) .....	1	98-Up	27076	89201
076	Axle (Right Side) (U240E) Celica GTS .....	1	98-Up	67076BA	75201A
076	Axle (Right Side) (U241E) Camry, RAV4 .....	1	98-Up	27076A	89201C
077	Axle (Left Side) (U140E, U140F) .....	1	98-Up	87077A	75201E
077	Axle (Left Side) (U240E) Celica GTS .....	1	98-Up	67076BA	75201A
077	Axle (Left Side) (U241E) Camry, RAV4 .....	1	98-Up	27077A	89201B
<b>FRICTION PLATES</b>					
102	Underdrive Brake (# 1) (40 T) (U140E, U140F) .....	3-4	98-Up	27102	89108
102	Underdrive Brake (# 1) (40 T) (U240E, U241E) .....	3-4	00-Up	27102B	89108A
102	Underdrive Brake (# 2) (28 T) (U140E, U140F) .....	3-4	98-Up	27102A	89110
102	Underdrive Brake (# 2) (28 T) (U240E, U241E) .....	3-4	00-Up	27102C	89110A
104	2nd Brake .....	3-4	98-Up	27104	89104
106	Direct .....	3-4	98-Up	27106	89102
108	Forward .....	5-6	98-Up	27108	89100
114	Low & Reverse .....	5-7	98-Up	27114	89106

ILL.	DESCRIPTION	QTY.	YEAR	PART NO.	REFERENCE NO.
<b>STEEL PLATES</b>					
122	Underdrive Brake (# 1) (40 T, 3.900" ID) (U140E, U140F).....	4	98-Up	27122	89109
122	Underdrive Brake (# 1) (40 T, 3.550" ID) (U240E, U241E).....	3	00-Up	27122B	89109A
122	Underdrive Brake (# 2) (11 T, 3.660" ID) (U140E, U140F).....	4	98-Up	27122A	89111
122	Underdrive Brake (# 2) (11 T, 3.510" ID) (U240E, U241E).....	3	00-Up	27122C	89111A
124	2nd Brake.....	4	98-Up	27124	89105
126	Direct.....	3-4	98-Up	27126	89103
128	Forward.....	5-6	98-Up	27128	89101
134	Low & Reverse.....	5-7	98-Up	27134	89107
<b>SEALING RINGS</b>					
175	Sealing Ring Kits.....	1	98-Up	27175	N/A
<b>THRUST WASHERS &amp; BEARINGS</b>					
238	Bearing, Between Sun Gear & Front Planet (U140E, U140F).....	1	01-03	27238	N/A
241	Washer, Rear Planet to Sprag & Sprag to Direct Hub.....	2	98-Up	27241	N/A
<b>GASKETS &amp; O-RINGS</b>					
300	Gasket, Pan (Fiber).....	1	98-Up	27300F	13547X
379	O-Ring, Filter.....	1	98-Up	27379	13476
<b>TECHNICAL MANUALS</b>					
400	Tech Guide (U140E, U240).....	1	98-Up	27400	N/A
400	Tech Manual (U140F).....	1	98-Up	27400A	89Y01
<b>ELECTRICAL COMPONENTS</b>					
410	Neutral Safety Switch (Exc. U240E).....	1	98-Up	27410	N/A
410	Neutral Safety Switch (U240E).....	1	98-Up	27410A	N/A
421	Solenoid, Shift # 1 Control (White Connector).....	1	98-Up	27421	5A-410
422	Solenoid, Shift # 2 Control (Neutral Connector).....	1	98-Up	27422	5A-411
423	Solenoid, Shift # 3 Control (Black Connector).....	1	98-Up	27423	5A-412
425	Solenoid, Lock-Up (Brown Connector).....	1	98-Up	27425	5A-413
431	Solenoid, EPC (White Connector).....	1	98-Up	27431	5A-414
446	Wire Harness (Exc. U240E).....	1	98-Up	27446	N/A
446	Wire Harness (U240E).....	1	98-Up	27446A	N/A
<b>HARD PARTS</b>					
<b>Prefix Key: D = OEM, A = Aftermarket New, R = Remanufactured</b>					
<b>PUMPS</b>					
500	Pump, Gear Type.....	1	98-Up	27500	89920
500	Pump, Rotor Type.....	1	98-Up	27500A	89920A
<b>DRUMS &amp; CLUTCH HUBS</b>					
550	Drum, Underdrive (2wd).....	1	98-Up	27550	88926
550	Drum, Underdrive (4wd).....	1	98-Up	27550A	88926A
554	Drum, Forward (5 Clutch) (U240).....	1	99-Up	27554	89921
554	Drum, Forward (6 Clutch) (U140).....	1	99-Up	27554A	89921A
555	Drum, Direct (3 Clutch) (U240).....	1	99-Up	27555A	89923A
555	Drum, Direct (4 Clutch) (U140).....	1	99-Up	27555	89923
574	Hub, Forward.....	1	98-Up	27574	89946
576	Hub, Reverse Brake.....	1	98-Up	27576	N/A

U140, U240E





# DRIVEN

## TO BE THE BEST IN...



# QUALITY PARTS

**TRANSTAR**  
TRANSTAR INDUSTRIES, INC.®

TRANSTAR INDUSTRIES, INC. • 7350 YOUNG DRIVE • CLEVELAND, OHIO 44146 • WWW.TRANSTAR1.COM

AT TRANSTAR, WE'RE DRIVEN TO BRING YOU THE PRODUCTS AND SERVICES YOU NEED TO HELP YOUR BUSINESS THRIVE. BEYOND BRINGING YOU QUALITY BRANDS, COMPETITIVE PRICING, WORLDWIDE DISTRIBUTION AND SAME-DAY SERVICE TO MOST U.S. MARKETS, WE BRING YOU THE INDUSTRY-LEADING ONLINE INVENTORY AND ORDERING TOOLS DESIGNED TO GIVE YOU THE EDGE.  
DRIVEN TO BE THE BEST FOR YOU.

800.359.3339 | [www.transtar1.com](http://www.transtar1.com) .....



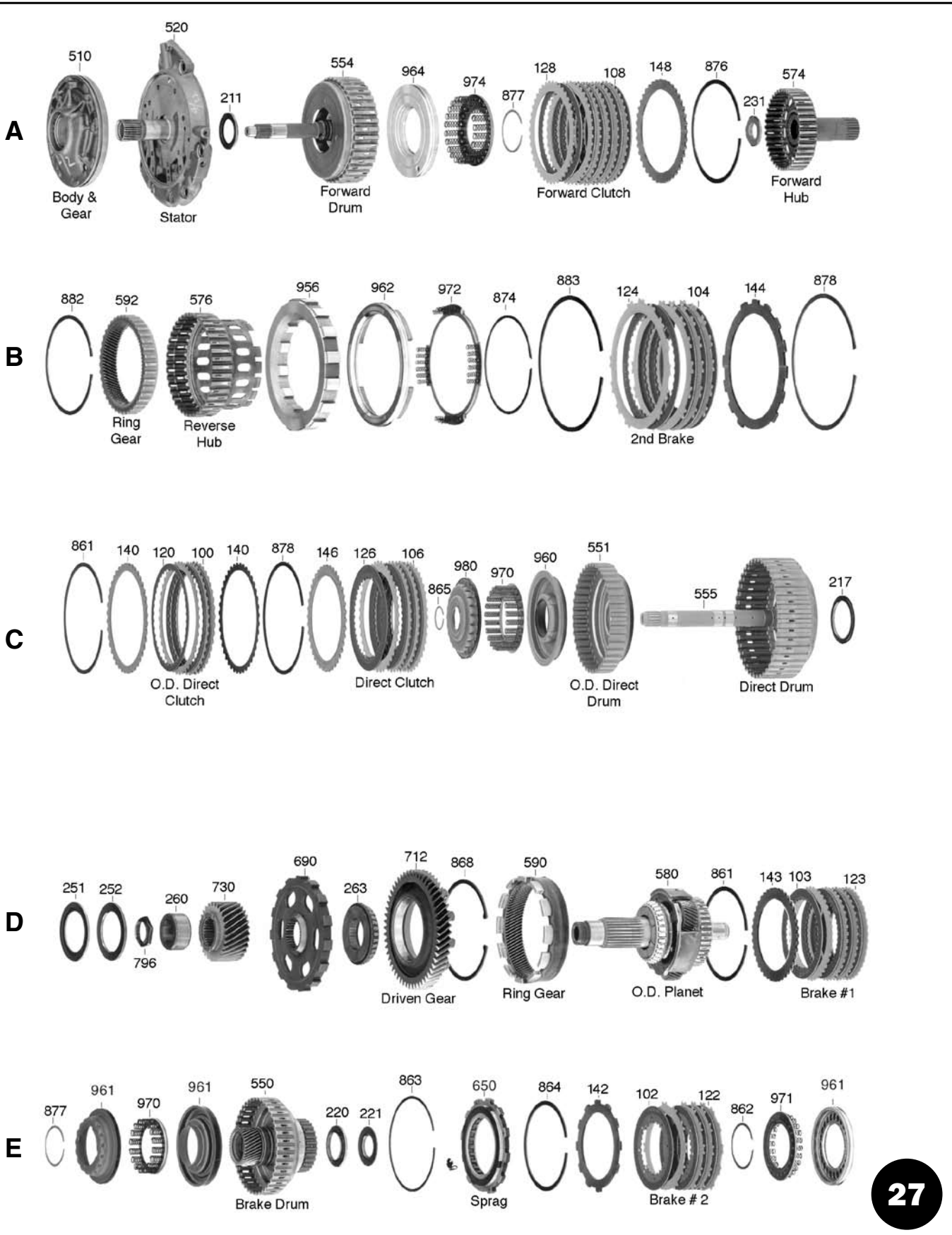

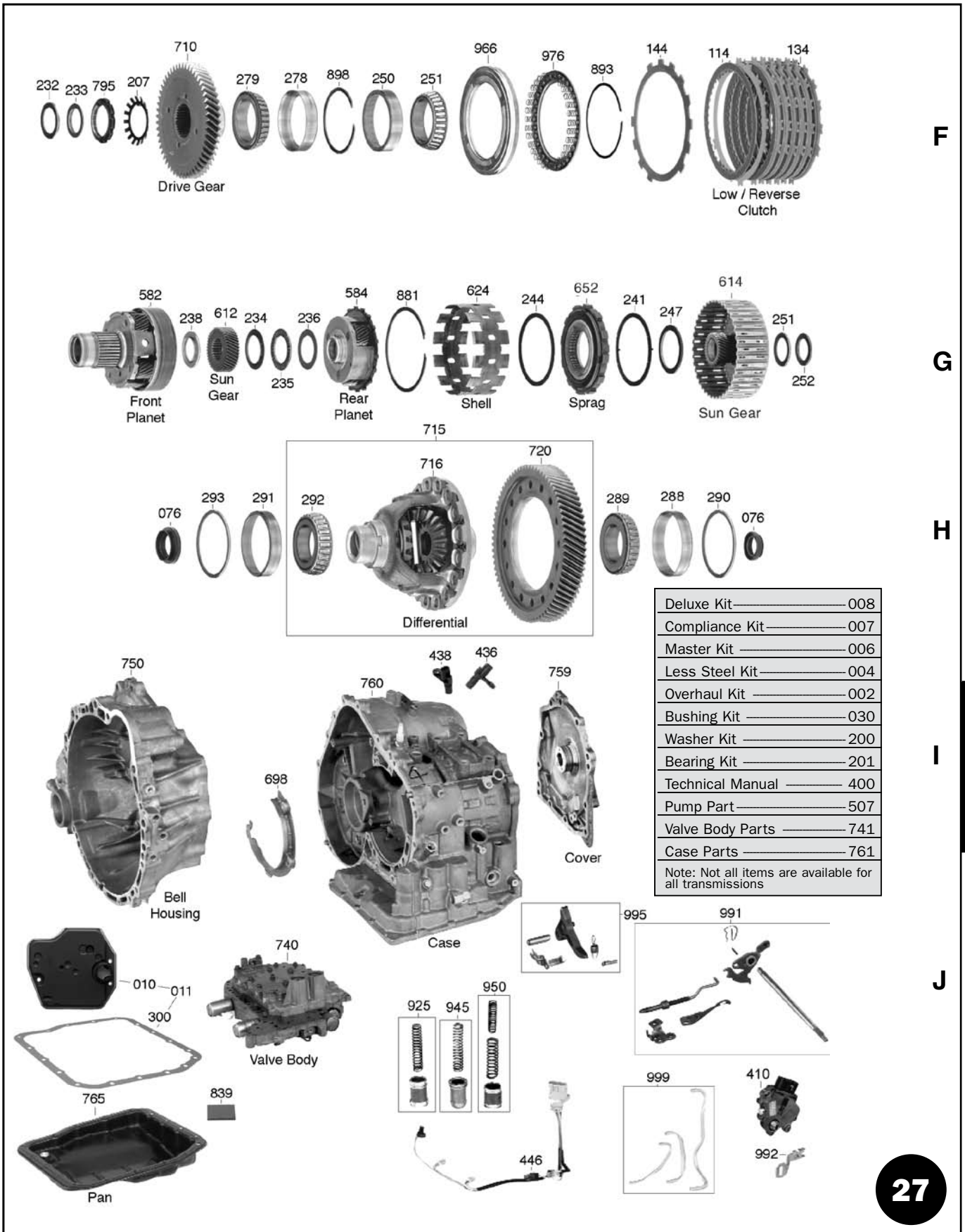

F

G

H

I

J

Deluxe Kit	008
Compliance Kit	007
Master Kit	006
Less Steel Kit	004
Overhaul Kit	002
Bushing Kit	030
Washer Kit	200
Bearing Kit	201
Technical Manual	400
Pump Part	507
Valve Body Parts	741
Case Parts	761
Note: Not all items are available for all transmissions	

U150, U151, U250

# TOYOTA

## U150, U151, U250

## FWD - 5 SPEED

ILL.	DESCRIPTION	QTY.	YEAR	PART NO.	REFERENCE NO.
<b>MASTER OVERHAUL KITS (WITH STEELS)</b>					
006	U150, U151 (w/ Bonded Pistons) .....	1	02-Up	27006B	K8900P
006	U250 (w/ Bonded Pistons) .....	1	02-Up	27006G	K8900G
<b>LESS STEEL KITS</b>					
004	U150, U151 (w/ Bonded Pistons) .....	1	02-Up	27004B	K8900P-LS
004	U250 (w/ Bonded Pistons) .....	1	02-Up	27004G	K8900G-LS
<b>OVERHAUL KITS (W/ RINGS &amp; SEALS)</b>					
002	U150, U151 (w/ Bonded Pistons) .....	1	02-Up	27002B	K89900P
002	U250 (w/ Bonded Pistons) .....	1	05-Up	27002G	K89900G
<b>SUB KITS</b>					
001	Sub Kit, Transfer Case (U151F) .....	1	02-Up	27001	K89900T
<b>FILTER KITS</b>					
011	U150, U151, U250 .....	1	02-Up	27011B	FK89800P
<b>FILTERS</b>					
010	U150, U151, U250 .....	1	02-Up	27010B	89800P
<b>BUSHINGS</b>					
030	Bushing Kit .....	1	02-Up	27030B	K89901P
034	Pump .....	1	02-Up	57034A	46001
<b>METAL CLAD SEALS</b>					
070	Front Pump .....	1	02-Up	57070A	46200B
076	Axle (Right side) (U150, U151) (2wd) .....	1	02-Up	87076A	75201D
070	Axle (Right side) (U150, U151) (4wd) .....	1	02-Up	27076	89201
076	Axle (Right Side) (U250) .....	1	02-Up	27076A	89201C
077	Axle (Left Side) (U150, U151) .....	1	02-Up	87077A	75201E
077	Axle (Left Side) (U250) .....	1	02-Up	27077A	89201B
<b>FRICTION PLATES</b>					
100	Overdrive Direct .....	4	02-Up	27100	89112
102	Underdrive # 1 (40 T) .....	4	02-Up	27102	89108
102	Underdrive # 2 (28 T) .....	4	02-Up	27102A	89110
104	2nd Brake .....	4	02-Up	27104	89104
106	Direct .....	3-4	02-Up	27106A	89102P
108	Forward .....	5-6	02-Up	27108	89100
114	Low/ Reverse .....	5-7	02-Up	27114	89106
<b>STEEL PLATES</b>					
120	Overdrive Direct .....	4	02-Up	27120	89113
122	Underdrive # 1 (40 T) .....	4	02-Up	27122	89109
122	Underdrive # 2 (11 T) .....	4	02-Up	27122A	89111
124	2nd Brake .....	4	02-Up	27124	89105
126	Direct .....	3-4	02-Up	27126A	89103P
128	Forward .....	5-6	02-Up	27128	89101
134	Low/ Reverse .....	5-7	02-Up	27134	89107
<b>GASKETS &amp; O-RINGS</b>					
300	Gasket, Pan (Fiber) .....	1	02-Up	27300F	13547X
379	O-Ring, Filter .....	1	02-Up	27379	13476

ILL.	DESCRIPTION	QTY.	YEAR	PART NO.	REFERENCE NO.
<b>SOLENOIDS</b>					
421	Shift # 1 Linear (White Connector, Large Body).....	1	02-Up	27421A	5A-410N
421	Shift # 1 Linear (Black Connector, Small Body).....	1	03-Up	27421B	5A-410P
422	Shift # 2 Linear, Position # 1 (White Connector, Large Body).....	1	02-Up	27422A	5A-411M
422	Shift # 2 Linear, Position # 2 (White Connector, Large Body).....	1	02-Up	27422C	5A-411N
422	Shift # 2 Linear (Black Connector, Small Body).....	2	03-Up	27422B	5A-411P
422	Shift # 3, Position # 1 (Black Connector, Long Bracket).....	1	02-Up	27423B	5A-412P
422	Shift # 3, Position # 2 (Black Connector, Short Bracket).....	1	02-Up	27423A	5A-412R
425	Lock-Up (Brown Connector).....	1	02-Up	27425A	5A-413P
431	EPC (White Connector, Large Body).....	1	02-Up	27431B	5A-414N
431	EPC (Black Connector, Small Body).....	1	03-Up	27431A	5A-414P
<b>HARD PARTS</b>					
Prefix Key: D = OEM, A = Aftermarket New, R = Remanufactured					
<b>PUMPS</b>					
500	Pump.....	1	02-Up	27500B	89920P
<b>DRUMS &amp; CLUTCH HUBS</b>					
550	Drum, Underdrive Sun Gear.....	1	02-Up	27550B	89926P
554	Drum, Forward (6 Clutch).....	1	02-Up	27554B	89921P
555	Drum, Direct.....	1	02-Up	27555B	89923P
571	Hub, Overdrive Direct.....	1	02-Up	27571B	89947P
574	Hub, Forward.....	1	02-Up	27574	89946
<b>PLANETS</b>					
582	Planet, Front (4 Gear).....	1	02-Up	27582B	89951P
584	Planet, Rear.....	1	02-Up	27584B	89956P
592	Ring Gear, Front Planet.....	1	02-Up	27592	N/A
<b>SUN GEARS, SHELLS &amp; SUPPORTS</b>					
612	Sun Gear, Front Planet.....	1	02-Up	27612B	89958P
624	Shell, Reaction.....	1	02-Up	27624B	89948P
<b>SPRAGS</b>					
650	Underdrive.....	1	02-Up	27650	89960
652	Rear (28 Elements).....	1	02-Up	27652	89940
652	Rear (22 Elements).....	1	02-Up	27652A	89940A
<b>MISCELLANEOUS COMPONENTS</b>					
961	Overdrive Direct Piston (Bonded).....	1	02-Up	27960	89538P
961	Overdrive Direct Retainer (Balance) (Bonded).....	1	02-Up	27960A	89539P
961	Underdrive Piston & Retainer Kit (Bonded) (U150, U151).....	1	02-Up	27961	89534
964	Forward Piston (Bonded).....	1	02-Up	27964A	89532P
964	Forward Piston Retainer (Balance) (Bonded).....	1	02-Up	27964B	89532P
551	Direct Piston (Bonded) (Part of the Overdrive Direct Drum).....	1	02-Up	27965A	89536P

U150, U151, U250

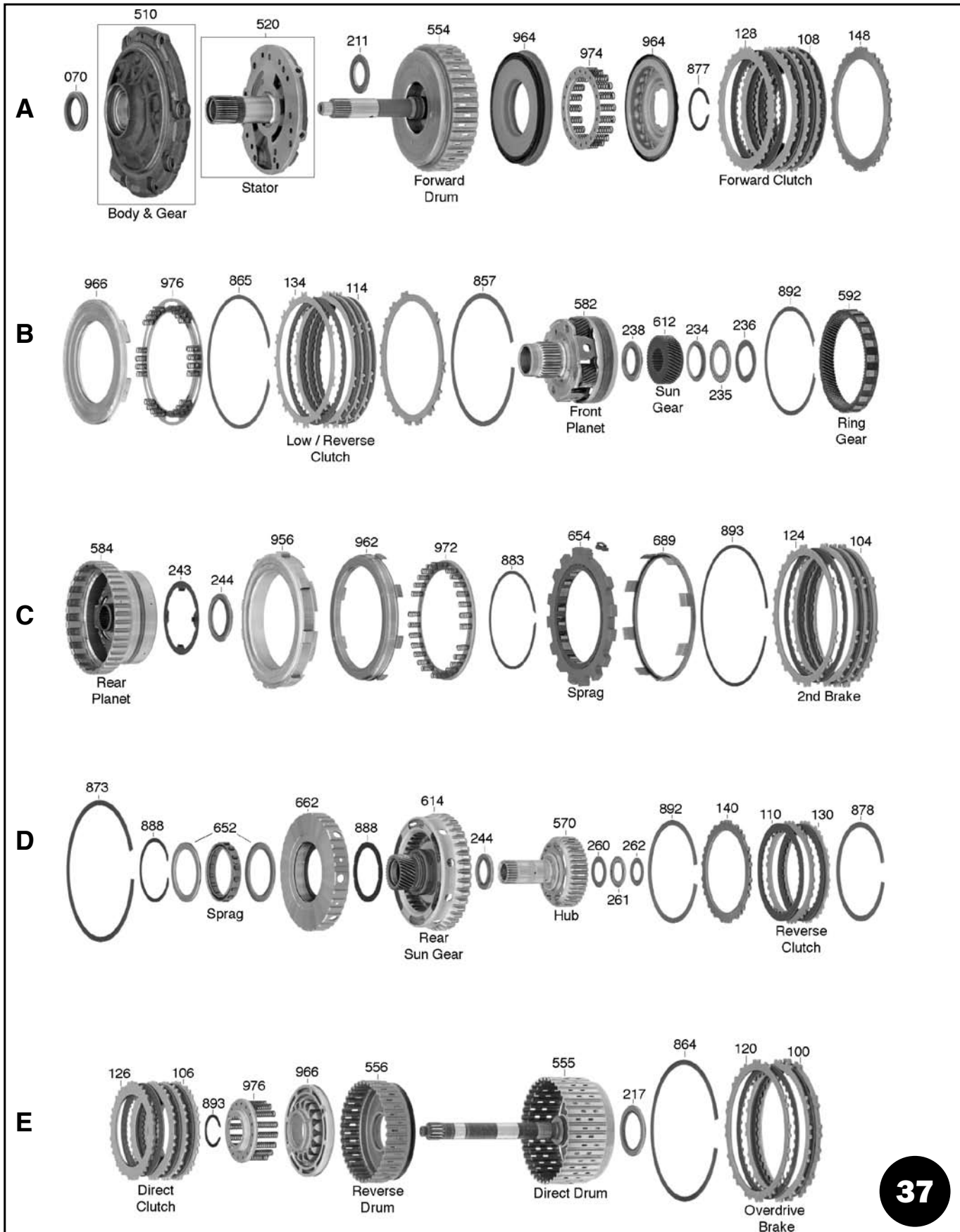

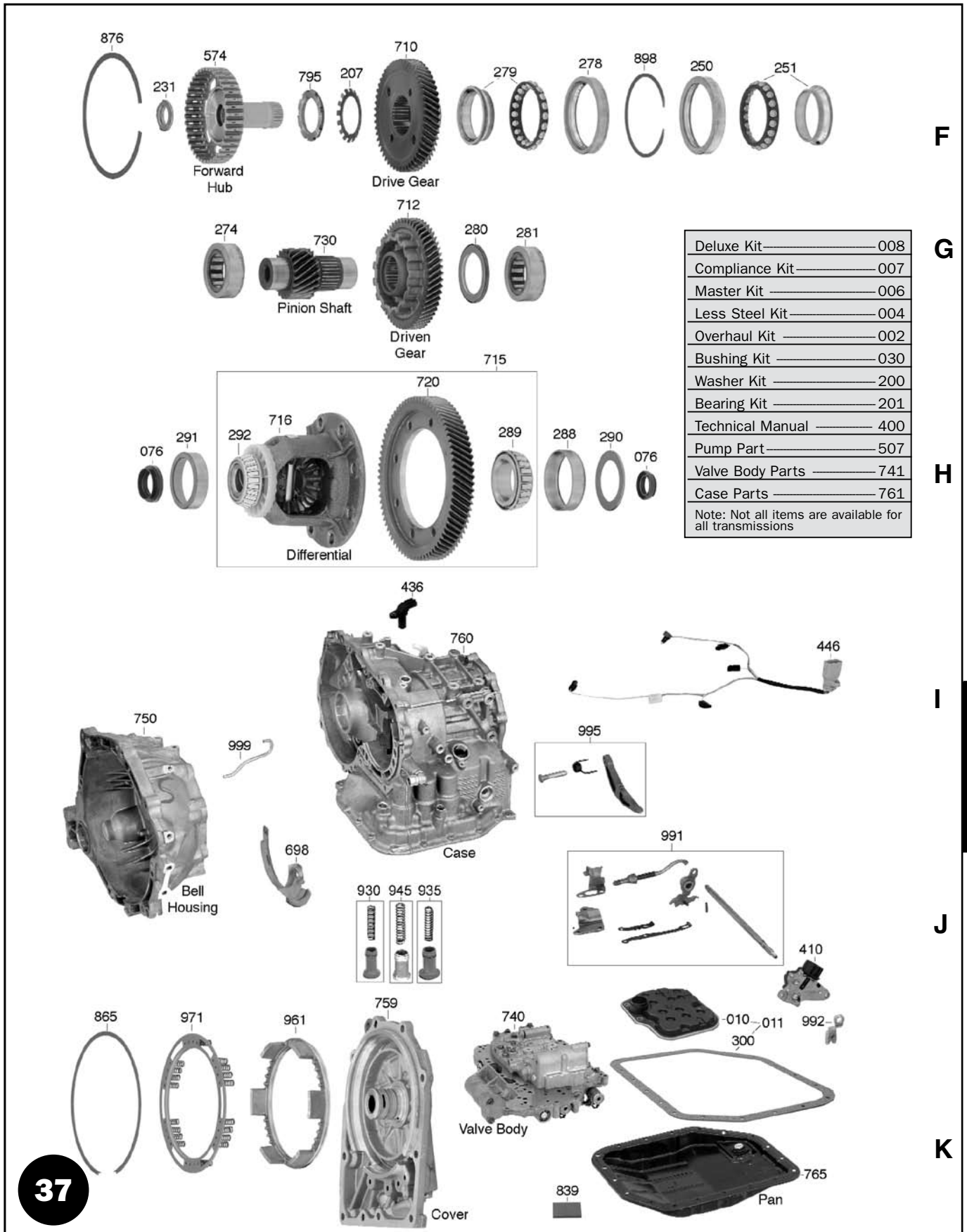

Deluxe Kit	008
Compliance Kit	007
Master Kit	006
Less Steel Kit	004
Overhaul Kit	002
Bushing Kit	030
Washer Kit	200
Bearing Kit	201
Technical Manual	400
Pump Part	507
Valve Body Parts	741
Case Parts	761
Note: Not all items are available for all transmissions	



# TOYOTA U340E SERIES, U341E SERIES

# FWD 4 SPEED

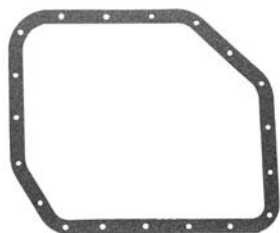

37300



37010

Echo	<b>A340E</b>	00-Up
Celica GT	<b>A341E</b>	00-Up
GM Vibe	<b>MU5</b>	03-Up

ILL.	DESCRIPTION	QTY.	YEAR	PART NO.	REFERENCE NO.
<b>MASTER OVERHAUL KITS (WITH STEELS)</b>					
006	U340E, U341E .....	1	00-Up	37006	K8900M
<b>LESS STEEL KITS</b>					
004	U340E, U341E .....	1	00-Up	37004	K8900M-LS
<b>OVERHAUL KITS (W/ RINGS &amp; SEALS)</b>					
002	U340E, U341E .....	1	00-Up	37002	K89900M
<b>FILTER KITS</b>					
011	U340E, U341E .....	1	00-Up	37011	FK89800M
<b>FILTERS</b>					
010	U340E, U341E .....	1	00-Up	37010	89800M
<b>METAL CLAD SEALS</b>					
070	Front Pump .....	1	00-Up	57070A	46200B
076	Axle (Right Side / Bell) (U340E) .....	1	00-Up	67076B	75201B
076	Axle (Right Side / Bell) (U341E) (Exc. Awd) .....	1	00-Up	67076BA	75201A
076	Axle (Right Side / Bell) (U341E) (Awd) .....	1	00-Up	37076	89201P
077	Axle (Left Side / Case) (U340E) .....	1	00-Up	67077	89201M
077	Axle (Left Side / Case) (U341E) .....	1	00-Up	37077	89201N
<b>FRICTION PLATES</b>					
100	Overdrive Brake .....	2	00-Up	37100	89114M
104	2nd Brake .....	3-4	00-Up	37104	89104M
106	Direct .....	3	00-Up	37106	89102M
108	Forward .....	4	00-Up	37108	89100M
110	Reverse .....	2-3	00-Up	37110	89112M
114	Low & Reverse .....	4	00-Up	37114	89106M
<b>STEEL PLATES</b>					
120	Overdrive Brake .....	2	00-Up	37120	89115M
124	2nd Brake (.079") (U341E) .....	3	00-Up	37124A	89105N
124	2nd Brake (.118") (U341E) .....	1	00-Up	37124	89105M
124	2nd Brake (.118") (U340E) .....	3	00-Up	37124	89105M
126	Direct .....	3	00-Up	37126	89103M
128	Forward .....	4	00-Up	37128	89101M
130	Reverse .....	2-3	00-Up	37130	89113M
134	Low & Reverse .....	4	00-Up	37134	89107M
<b>SEALING RINGS</b>					
175	Sealing Ring Kit .....	1	00-Up	37175	N/A
<b>GASKETS &amp; O-RINGS</b>					
300	Gasket, Pan .....	1	00-Up	37300	13547M

# FWD 4 SPEED

# TOYOTA U340E SERIES, U341E SERIES

ILL.	DESCRIPTION	QTY.	YEAR	PART NO.	REFERENCE NO.
<b>ELECTRICAL COMPONENTS</b>					
410	Neutral Safety Switch .....	1	00-Up	37410	N/A
421	Solenoid, Shift # 1 .....	1	00-Up	37421	5A-420
422	Solenoid, Shift # 2 .....	1	00-Up	37422A	5A-421
422	Solenoid, Shift # 3 .....	1	00-Up	37422	5A-422
425	Solenoid, Lock-Up (TCC).....	1	00-Up	37425	5A-423
431	Solenoid, EPC (U340E) .....	1	00-Up	37431A	5A-424
431	Solenoid, EPC (U341E) .....	1	00-Up	37431	5A-424A
436	Sensor, Output Speed (VSS).....	1	00-Up	37436	N/A
438	Sensor, Input Speed (TSS) .....	1	00-Up	37438	N/A
446	Wire Harness .....	1	00-Up	37446	N/A
<b>SPRAGS</b>					
652	No. 1 .....	1	00-Up	37652	89940M
654	No. 2 .....	1	00-Up	37654	89960M
<b>MISCELLANEOUS COMPONENTS</b>					
964	Forward Piston & Retainer Kit (Bonded).....	1	00-Up	37964	89532M
965	Direct (Reverse) Piston (Bonded) .....	1	00-Up	37966	89536M

# TOYOTA 6 SPEED U660

ILL.	DESCRIPTION	QTY.	YEAR	PART NO.	REFERENCE NO.
<b>MASTER OVERHAUL KITS (WITH STEELS)</b>					
006	U660 (Six Speed).....	1	07-Up	47006	N/A
<b>LESS STEEL KITS</b>					
004	U660 (Six Speed).....	1	07-Up	47004	N/A
<b>OVERHAUL KITS (W/ RINGS &amp; SEALS)</b>					
002	U660 (Six Speed).....	1	07-Up	47002	N/A
<b>FILTERS</b>					
010	U660 (Six Speed).....	1	07-Up	47010	N/A

U340, U341E